

SOLDIER'S MANUAL AND TRAINER'S GUIDE

MOS 02K

BASSOON PLAYER

Skill Levels 1 and 2

SOLDIER'S MANUAL AND TRAINER'S GUIDE

MOS 02K

BASSOON PLAYER

Skill Levels 1 and 2

TABLE OF CONTENTS

	<u>PAGE</u>
Table of Contents.....	i
PREFACE	iii
Chapter 1. Introduction.....	1-1
Chapter 2. Training Guide	2-1
Chapter 3. MOS/Skill Level Tasks	3-1
Skill Level 1	
Subject Area 1: Musical Tasks	
514-450-1302 Tune Your Bassoon To A Given Pitch.....	3-1
514-450-1732 Prepare A Bassoon Part For Band Performance	3-2
514-450-1733 Perform A Bassoon Part In A Non-Marching/Non-Ceremonial Setting At A 2.7 Performance Level.....	3-4
514-452-1712 Perform Auxiliary Percussion In A Marching/Ceremonial Setting	3-5
514-450-1402 Construct Bassoon Reeds.....	3-24
514-450-1401 Perform Player Maintenance On A Bassoon.....	3-29
Subject Area 2: Administrative Tasks	
121-004-1228 File Records	3-32
121-004-1515 Post Regulations And Directives	3-32
121-030-1507 Safeguard "For Official Use Only" (FOUO) Material	3-34

DISTRIBUTION RESTRICTION: Approved for public release; distribution is unlimited.

*This publication supercedes STP 12-02GHJKLQ14-SM dated 16 November 1984.

Subject Area 3: Tactical Tasks

191-376-4108 Operate A Dismount Point 3-35
 514-441-1201 Control Access to a Restricted Area 3-36
 514-441-1202 Perform Perimeter Security 3-37
 031-507-1002 Decontaminate Equipment Using ABC-M11 Decontamination Apparatus 3-40
 071-710-0008 Operate Night Vision Goggles AN/PVS-7 3-41
 071-710-0009 Maintain Night Vision Goggles AN/PVS-7 3-46
 113-587-1064 Prepare SINGARS (Manpack) For Operation 3-49
 113-588-1087 Install A Hot Loop 3-50
 113-600-1012 Install Telephone Set TA-312/PT 3-51
 113-600-2007 Operate Telephone Set TA-312/PT 3-53
 113-600-3015 Perform Operator PMCS On Telephone Set TA-312/PT 3-54

Skill Level 2

Subject Area 2: Administrative Tasks

514-464-2191 Perform Music Librarian Functions 3-55
 101-521-1102 Prepare And Process Personal Clothing Request 3-56
 101-521-1103 Prepare And Maintain Organization Clothing And Individual Equipment
 Record 3-57

Subject Area 3: Tactical Tasks

031-504-1008 Operate The M8A1 Alarm System 3-58

APPENDIX A - SWING RHYTHMS A-1

APPENDIX B - IMPROVISATION B-1

Glossary Glossary-1

References References-1

PREFACE

This publication is for skill level 1 and 2 soldiers holding Military Occupational Specialty (MOS) 02K and for trainers and first-line supervisors. It contains standardized training objectives, in the form of task summaries, to train and evaluate soldiers on critical tasks that support unit missions during wartime. Trainers and first-line supervisors should ensure soldiers holding MOS 02K skill levels 1 and 2 have access to this publication. It should be made available in the soldier's work area, unit learning center, and unit libraries.

This manual applies to both Active and Reserve Army soldiers. The proponent of this publication is the U.S. Army Element, School of Music, Norfolk, VA 23521-2617. Users of this publication are encouraged to recommend changes and submit comments for its improvement. Comments should be keyed to specific page, paragraph, and line of the text in which the change is recommended. Provide reasons for each comment to ensure understanding and complete evaluation. Send comments and recommendations on DA Form 2028 (Recommended Changes to Publications and Blank Forms) directly to Commandant, U.S. Army Element, School of Music, ATTN: ATSG-SM-TD, Norfolk, VA 23521-2617.

Unless this publication states otherwise, masculine nouns and pronouns do not refer exclusively to men.

CHAPTER 1

Introduction

1-1. General: This manual identifies the individual Military Occupational Specialty (MOS) training requirements for soldiers in MOS 02K in skill levels 1 and 2. Commanders, trainers, and soldiers should use it to plan, conduct, and evaluate individual training in units. This manual is the primary MOS reference to support the self-development and training of soldiers.

The tasks related to musical performance in this manual are not meant to teach a soldier to be a musician. The tasks serve as a guide for leaders to evaluate performance and to ensure soldiers in skill levels 1 and 2 understand their musical responsibilities. Other publications in the references will allow soldiers and leaders to learn more about specific technical skills related to musical performance. Units should make every attempt to stock these references in their music library.

Other skill level 1 and 2 critical tasks that are not available for reference in the *Soldier's Manual of Common Tasks* (STP 21-1-SMCT and STP 21-24-SMCT) have been added to this manual. Those tasks are categorized into two areas: administrative tasks and tactical tasks. Use this manual with intent to establish effective training plans and programs that integrate soldier, leader and collective tasks. *Soldier's Manual of Common Tasks* (STP 21-1-SMCT and STP 21-24-SMCT), *Army Training and Evaluation Programs* (ARTEP) and FM 25-101, *Battle Focused Training* should be referenced during training plan development.

1-2. Commander's Responsibilities: It is the responsibility of the commander to integrate individual and collective training in the unit's training plan. The training plan located in Chapter 2 of this STP should be utilized to support integration, train-up, and sustainment training of all band members in MOS 02K.

1-3. Trainer's Responsibilities: Training individual tasks to standard and relating this training to collective mission essential tasks is the NCO trainer's responsibility. The first-line supervisors are the principal trainers in the band because they directly supervise the soldiers.

It is the trainer's responsibility to tell the soldiers which tasks they must be able to perform. The trainer must also tell the soldiers which tasks need further training. Trainers use the steps below to plan and evaluate training:

- **Plan the training.** The NCO determines which tasks need to be trained based on the commander's training strategy. Training for specific tasks can usually be integrated or conducted concurrently with other training. The trainer should identify individual tasks that can be trained and evaluated concurrently with collective task training and evaluation.
- **Gather the training references and materials.** This information is listed in each task summary. Additional references are provided in the References section.
- **Train each soldier.** Show the soldier how to do the task to standard and explain step-by-step how to do the task.
- **Check each soldier.** Evaluate how well each soldier performs each task. These evaluations may be conducted during individual training sessions or while evaluating individual proficiency of unit collective task training. An evaluation guide has been provided, for each task in this manual, to help the trainer conduct year-round, hands-on evaluations of critical tasks. The training plan contains information to use as a guide in determining how often to evaluate a soldier's task performance.
- **Record the results.** The leader book referred to in FM 25-101, Appendix B, is used to record task performance, and gives the leader total flexibility with respect to methods of documentation.

- **Retrain and evaluate.** Work with each soldier until he can perform the task to specific standards. Well-planned, integrated training increases the professional competence of each soldier and contributes to the development of an efficient unit. The NCO or first-line supervisor is a vital link in the conduct of training.

1-4. Soldier's Responsibilities: Each soldier is responsible for performing individual tasks. The first-line supervisor identifies individual tasks based on the unit's mission essential task list (METL). The soldier must perform the task to the standard listed in the Soldier's Manual (SM). If a soldier has a question about how to do the task or which tasks in this manual he must perform, it is the soldier's responsibility to ask the first-line supervisor for clarification. The first-line supervisor knows how to perform each task and can direct the soldier to appropriate training materials.

1-5. NCO Self-Development and the Soldier's Manual: Self-development is one of the key components of the leader development program. It is a planned, progressive, and sequential program followed by leaders to enhance and sustain their military competencies. It consists of individual study, research, professional reading, practice, and self-assessment. Under the self-development concept, the NCO, as an Army professional, has the responsibility to remain current in all phases of the MOS. The SM is the primary source for maintaining MOS proficiency.

Another important resource for NCO self-development is the Army Correspondence Course Program (ACCP). For information on enrolling in this program and a list of courses, refer to DA Pamphlet 350-59, www.atsc.army.mil/accp/aipd.htm or write to: Army Institute of Professional Development, U.S. Army Training Support Center, ATTN: ATIC-IPS, Newport News, VA 23628.

1-6. Task Summaries: Task summaries outline the wartime performance requirements of each critical task in the Soldier's Manual. They provide the soldier and the trainer with the information necessary to prepare, conduct, and evaluate critical task training. As a minimum, task summaries include information you must know, and the skills that you must perform to standard for each task. The format for the task summaries included in this SM is as follows:

- **Task Title.** The task title identifies the action to be performed.
- **Task Number.** The task number is a 10-digit number that identifies each task or skill. Include this task number, along with the task title, in any correspondence relating to the task.
- **Conditions.** The task conditions identify all the equipment, tools, references, job aids, and supporting personnel which the soldier needs to perform the task in wartime. This section identifies any environmental conditions such as visibility, temperature, and wind that can alter task performance. This section also identifies any specific cues or events that trigger task performance.
- **Standards.** The task standards describe how well and to what level you must perform a task under wartime conditions. Standards are typically described in terms of accuracy, completeness, and speed.
- **Training and Evaluation.** This section may contain all or part of the following: training information outline, evaluation preparation subsection, and evaluation guide. The training information outline includes detailed training information. The evaluation preparation subsection indicates necessary modifications to task performance in order to train and evaluate a task that cannot be trained to the wartime standard under wartime conditions. It may also include special training and evaluation preparation instructions to accommodate these modifications and any instructions that should be given to the soldier before evaluation. The evaluation guide identifies the specific actions, known as performance measures, that the soldier must do to successfully complete the task. These actions are listed in a "GO/NO-GO" format for easy evaluation. Each evaluation guide contains a feedback statement that indicates the requirements (for example, number of performance measures "passed") for receiving a "GO" on the evaluation.

- **References.** This section identifies references that provide more detailed and thorough explanations of task performance requirements.

Additionally, some task summaries include safety statements and notes. Safety statements (danger, warning, caution) alert users to the possibility of immediate death, personal injury, or damage to equipment. Notes provide a small, extra supportive explanation or hint relative to the performance measures.

1-7. MOS Training Plan: Information necessary for planning training for musicians in MOS 02K is listed in the training plan in Chapter 2 of this manual. Leaders should use this plan in conjunction with the *Soldier's Manual of Common Tasks* (STP 21-1-SMCT and STP 21-24-SMCT), *Army Training and Evaluation Programs* (ARTEP) and FM 25-101, *Battle Focused Training* to develop an individual training plan for soldiers in their unit. The training plan:

- Identifies subject areas that must be trained.
- Identifies the critical tasks for each subject area.
- Specifies where musicians are initially trained on each task.
- Specifies the references needed to train the tasks.
- Recommends how often each task should be trained to sustain proficiency.

1-8. Training Support: This manual includes the following additional training support information:

- **Appendix A.** Swing Rhythms
- **Appendix B.** Improvisation
- **Glossary.** The glossary, which follows the last appendix, is a single comprehensive list of acronyms, abbreviations, definitions, and letter symbols.
- **References.** Professional references (books and web sites) have been listed to aid in technical skill development. This listing is not intended to be all-inclusive, and some of the sites have extensive links pages. No endorsement by any government agency is implied in the inclusion of any links on this page.

Reserve Components (Army National Guard and Army Reserve): All tasks in this manual are applicable to both the Active and Reserve Army soldiers. However, some tasks may require modification due to differences of equipment, facilities and available training time.

CHAPTER 2

Training Guide

2-1. General. The training plan identifies the essential components of a unit training plan for individual training. Units have different training needs and requirements based on differences in environment, location, equipment, dispersion, and similar factors. Therefore, the training plan should be used as a guide for conducting unit training and not a rigid standard. The plan is designed to assist the commander in preparing a unit training plan which satisfies integration, cross training, training up, and sustainment training requirements for soldiers in this MOS. The training plan shows the critical task grouped by task commonality into subject areas.

Subject Area column. This column lists the subject area number and title.

Task Number column. This column lists the task numbers for all tasks included in the subject area.

Title column. This column lists the task title for each task in the subject area.

Training Location column. This column identifies the training location where the task is first trained to soldier training publication's standards. If the task is first trained to standard in the unit, the word "Unit" will be in this column. If the task is first trained to standard in the training base, it will identify, by brevity code (e.g. AIT), the resident course where the task was taught. Figure 2-1 contains a list of training locations and their corresponding brevity codes.

UNIT	Trained in the Unit
AIT	Advanced Individual Training

Figure 2-1
Training Locations

Sustainment Training Frequency column. This column indicates the recommended frequency at which the tasks should be trained to ensure soldiers maintain task proficiency. Figure 2-2 identifies the frequency codes used in this column.

AN	- Annually
MO	- Monthly
WK	- Weekly
DA	- Daily

Figure 2-2
Sustainment Training Frequency Codes

Sustainment Training Skill Level column. This column lists the skill levels of the MOS for which soldiers must receive sustainment training to ensure they maintain proficiency to Soldier's Manual standards.

2-2. Subject Area Codes.

Skill Level 1 & 2

- Subject Area 1 - Musical Tasks
- Subject Area 2 - Administrative (Admin) Tasks
- Subject Area 3 - Tactical Tasks

2-3. Critical Tasks List.

TRAINING PLAN MOS 02K

CRITICAL TASKS

Subject Area	Task Number	Title	Training Location	Sust Tng Freq	Sust Tng SL
Skill Level 1					
1. Musical Tasks	514-450-1302	Tune Your Bassoon To A Given Pitch	AIT	DA	1-4
	514-450-1401	Perform Player Maintenance On An Bassoon	AIT	AN	1-2
	514-450-1402	Construct Bassoon Reeds	AIT	WK	1-4
	514-450-1732	Prepare An Bassoon Part For Band Performance	AIT	DA	1-4
	514-450-1733	Perform An Bassoon Part In A Non-Marching/Non-Ceremonial Setting At A 2.7 Performance Level	AIT	DA	1-4
	514-452-1712	Perform Auxiliary Percussion In A Marching/Ceremonial Setting	AIT	WK	1-4
2. Admin Tasks	121-004-1228	File Records	UNIT	AN	1-2
	121-004-1515	Post Regulations And Directives	UNIT	AN	1-2
	121-030-1507	Safeguard "For Official Use Only" (FOUO) Material	UNIT	AN	1-3
3. Tactical Tasks	031-507-1002	Decontaminate Equipment Using ABC-M11 Decontamination Apparatus	UNIT	AN	1-3
	071-710-0008	Operate Night Vision Goggles AN/PVS-7	UNIT	AN	1-4
	071-710-0009	Maintain Night Vision Goggles AN/PVS-7	UNIT	AN	1-4
	113-587-1064	Prepare SINGARS (Manpack) For Operation	UNIT	AN	1-3
	113-588-1087	Install A Hot Loop	UNIT	AN	1-2
	113-600-1012	Install Telephone Set TA-312/PT	UNIT	AN	1-2
	113-600-2007	Operate Telephone Set TA-312/PT	UNIT	AN	1-2
	113-600-3015	Perform Operator PMCS On Telephone Set TA-312/PT	UNIT	AN	1-2
	191-376-4108	Operate A Dismount Point	UNIT	AN	1-3
	514-441-1201	Control Access to a Restricted Area	UNIT	AN	1-2
514-441-1202	Perform Perimeter Security	UNIT	AN	1-2	

TRAINING PLAN MOS 02K**CRITICAL TASKS**

Skill Level 2					
2. Admin Tasks	101-521-1102	Prepare And Process Personal Clothing Request	UNIT	AN	1-2
	101-521-1103	Prepare And Maintain Organization Clothing And Individual Equipment Record	UNIT	AN	1-2
	514-464-2191	Perform Music Librarian Functions	UNIT	AN	1-2
3. Tactical Tasks	031-504-1008	Operate The M8A1 Alarm System	UNIT	AN	1-4

ADJUTANT GENERAL BRANCH

NCO CAREER DEVELOPMENT MODEL
 CAREER MANAGEMENT FIELD: ARMY BANDS
 CMF NUMBER: 97

RANK	PFC/SPC/CPL	SGT	SSG
DUTY ASSIGNMENTS	Instrumentalist (1)	Sr. Instrumentalist (1)	Section Ldr (1)
	GS Instrumentalist (2)	GS Sr. Instrumentalist (2)	GS Section Ldr (2)
ADDITIONAL DUTY POSITIONS	Asst Squad Ldr	Squad Ldr	Platoon SGT
		Asst ADMIN/OPS/TNG/ SUPPLY	ADMIN/OPS/TNG/ SUPPLY NCOIC
		Recruiter/Drill SGT/USAESOM Staff	
INSTITUTIONAL TRAINING	BCT/AIT		
	PLDC	BNCOC	ANCOC
RECOMMENDED NCOES-RELATED COURSES	PRIOR TO PLDC	PRIOR TO BNCOC	PRIOR TO ANCOC
	English Composition	Comm skills	Principles of Management
	Basic Mathematics	Pers Supervision	Organizational Behavior
	Computer Literacy	Behavioral Science	Information Systems Management
	ACCP Gen Mil Subj	ACCP #514M01 (RC Only- Required) ACCP #514M05 (AC Only)	Technical Writing ACCP #514M03 (RC Only - Required) ACCP #514M07 (AC Only)
RECOMMENDED CMF-RELATED COURSES AND ACTIVITIES	SKILL LEVEL 10	SKILL LEVEL 20	SKILL LEVEL 30
	Applied Instrumental Lessons	App Instr Lessons 1 Intermediate Theory	App Instr Lessons 2 Basic Comp/Arranging
	Basic Theory	Inter Music History	Basic Conducting
	Basic Music History	Advanced Sight Singing/ Ear Training	Basic Rehearsal Tech Basic Orchestration
	Basic Sight Singing/ Ear Training	Keyboard Tech (All MOS) Woodwind Techniques (MOS 02G, H, J, K, L)	Sight Singing/Ear Tng Sustainment Training
			Woodwind Techniques (MOS 02G, H, J, K, L)
		Brass Techniques (MOS 02B, C, D, E, F)	
			Brass Techniques (MOS 02B, C, D, E, F)
		Percussion Techniques (MOS 02M, N, T, U)	
			Percussion Techniques (MOS 02M, N, T, U)
	RECOMMENDED CMF RELATED CERTIFICATION/DEGREE GOAL	AA/AS in: Music By The 6th Year Of Service	
NOTE	* See DA PAM 600-67. The Army Writing Standard is writing that can be understood in a single, rapid reading; and is generally free of errors in grammar, mechanics and usage		
LEGEND	ACCP - Army Correspondence Course Program		
Notes:	. 1. As member of a Direct Support Band 2. As a member of a General Support Band		
Career Development PVT-SGM MOS offers career progression in TOE/TDA (majority TOE)			
Drill Sergeants:	4	Females Asgn:	1
Recruiters:	15		
Instructors:	24		
First Sergeants:	26		
Equal Opportunity:	0		
CMF 97 (Total) TDA 159 / TOE 1840	8% / 92%		

ADJUTANT GENERAL BRANCH

**NCO CAREER DEVELOPMENT MODEL
CAREER MANAGEMENT FIELD: ARMY BANDS
CMF NUMBER: 97**

RANK	SFC	MSG/1SG	SGM
DUTY ASSIGNMENTS	Group LDR (1)	FIRST SERGEANT (1)	Band SGM
	GS Section LDR (2)	GS GRP LDR (2)	Band SGM
ADDITIONAL DUTY POSITIONS	PLATOON SGT		
	ADMIN/OPS/TNG/SUPPLY Supervisor		
	Recruiter/Drill SGT/USAESOM Staff		
INSTITUTIONAL TRAINING		SERGEANTS MAJOR COURSE	
RECOMMENDED NCOES-RELATED COURSES		PRIOR TO SMC	
		Research Techniques (Statistics)	
		Human Resource Management	
		ACCP #514F11 (RC & AC)	
	RECOMMENDED 1SG Course	ACCP Advanced Military Subjects	
RECOMMENDED CMF-RELATED COURSES AND ACTIVITIES	SKILL LEVEL 40	SKILL LEVEL 50	
	App Instr Lessons 3	App Instr Lessons 4	
	Adv Conducting 1	Adv Conducting 2	
	Adv Rehearsal Tech	Jazz Composition/Arranging	
	Music Harmony	Music Amplification Techniques	
	Music Counterpoint		
	Adv Comp/Arranging		
	Music Literature		
	Sight Singing/Ear Tng		
	Sustainment Training		
	Arranging Popular Music		
	RECOMMENDED CMF RELATED CERTIFICATION DEGREE/GOAL	BA/BS in: Music by the 10 th year of service.	
NOTE	APPROVED BY: Chief, Army Bands		
	DATE: 10 JULY 2000 UPDATED: 16 JANUARY 2000		

CHAPTER 3

MOS/Skill Level Tasks

Skill Level 1

Subject Area 1: Musical Tasks

Tune Your Bassoon To A Given Pitch

514-450-1302

Conditions: Given a bassoon, adequate warm up time, and a reference pitch, tune your instrument to the given pitch.

Standards: Tuned instrument to within (\pm)5 cents of the reference pitch within thirty seconds.

Performance Steps

1. Listen to the reference pitch.
 - a. Best pitch for tuning the bassoon is concert A.
 - b. Tuning to one note does not ensure good intonation throughout the full range of the instrument.
2. Play the same pitch on your instrument at equivalent volume to reference pitch.
3. Listen for pulsations against reference pitch. Pulsations indicate performed pitch is sharp or flat to reference pitch.
4. Use embouchure or mouth/throat cavity adjustments to match reference pitch. This technique has the greatest effect in the middle register, less so in the upper and lower register.
 - a. If the performed pitch is sharp, lower the larynx to flatten a note.
 - b. If the performed pitch is flat, raise the larynx to sharp a note.
 - c. The pulsations will be faster the further you are from the reference pitch. The pulsations will stop when you have matched the performed pitch to the reference pitch.
5. Complete steps one through four within thirty seconds.

Comment [DK1]: Not really needed.....no other books gave an explanation why not to use a different pitch

Comment [DK2]: do you mean mouth cavity as in one portion of the mouth or mouth/cavity as in 2 portions of the face?

NOTE: Listed below are alternate methods of pitch adjustment, but due to time constraints, will not be used for this task.

- a. The first wire can be repositioned closer to the tip to widen the throat and lower the pitch.
- b. The first wire can be repositioned closer to the base of the reed to narrow the throat and raise the pitch.
- c. You can also slightly shorten the tip length.
- d. If consistently sharp or flat, you may have to change bocals. The bocal is always pushed in all the way.

Comment [DK3]: should be flush left

Comment [DK4]: is this a separate method to adjust pitch or part of the wire repositioning? If it a separate method, it should have it's own line.

Comment [DK5]: is this a separate method to adjust pitch or part of the wire repositioning? If it a separate method, it should have it's own line.

Evaluation Preparation:

Setup: Ensure that all materials required in the Conditions statement are available to the soldier. Evaluate this task during individual or collective training. The evaluator will need a room free from outside noise, a stopwatch, a reference pitch and a tuner to measure the soldier's pitch accuracy. The evaluator will inform the soldier of the reference that will be sounded (e.g. "B" flat) and will then sound the reference pitch at five-second intervals, allowing the pitch to sound for five seconds. The soldier will listen to the pitch, play it, and make necessary adjustments to match the reference pitch. Allow the soldier to up to 30 seconds to complete this task. At the end of 30 seconds, ask the soldier to play the pitch. Check the tuner to verify the soldier is within (\pm)5 cents of the reference pitch.

Brief the soldier: "You will have 30 seconds to tune your instrument within (±)5 cents of the reference pitch. The reference pitch will be sounded at five-second intervals. You may adjust your instrument as often as needed until you match pitch with the reference pitch or time has expired. At the end of 30 seconds, I will have you play the pitch and verify if you have met the standard."

Performance Measures

GO NO GO

- | | | |
|--|---|---|
| 1. Played the pitch while reference pitch was sounding. | — | — |
| 2. Adjusted mouth/throat cavity to match pitch within (±)5 cents of the reference pitch. | — | — |
| 3. Completed all steps within 30 seconds. | — | — |

Comment [DK6]: You told them to adjust embouchure or mouth/cavity. Also if you changed mouth/cavity earlier, you should change it again here.

Evaluation Guidance: Score the soldier GO if all steps are performed correctly. Score the soldier NO-GO if any step is performed incorrectly. If the soldier fails any step, explain the error to correct performance.

References

Required

Related
TC 12-41
TC 12-42

Prepare A Bassoon Part For Band Performance
514-450-1732

Conditions: Given an instrument, an individual rehearsal area, music to prepare for band performance, appropriate musical references, necessary accessories, and the requirement to prepare a bassoon part for band performance. You have warmed up and tuned your instrument.

Standards: Played all musical performance indicators or detected, isolated, analyzed, and corrected performance errors.

Comment [DK7]: Add a period

Performance Steps

1. Study assigned part and identify the following musical indicators:
 - a. Time signatures, meter changes, tempo markings
 - b. Key signatures, modulations, accidentals
 - c. Musical style
 - d. Articulations, entrances, cutoffs
 - e. Rhythms, dynamics, phrasing
 - f. Scale patterns, arpeggios, intervals
 - g. Strain endings: Da Capo(D.C.), Dal Segno(D.S.), Repeats, Coda
2. Perform assigned part observing all musical indicators.
 - a. Task is complete if all indicators are observed and no performance errors occur.
 - b. If errors are detected, continue with step 3.
3. Isolate error.

Comment [DK8]: complete

4. Analyze error:
 - a. Incorrect pitch
 - b. Incorrect rhythm
 - c. Incorrect expression (articulation, style, phrasing)
 - d. Incorrect performance direction (repeat, dynamics)
5. Correct error:
 - a. Break difficult passages into smaller elements to practice.
 - b. Reduce tempo for practice; increase tempo as passage is mastered.
 - c. Use sight singing, count and clap, and conduct and intone methods to work problem areas.
 - d. Use metronome and tuner to facilitate practice.
 - e. Reference and practice technical exercises to overcome performer deficiencies.

Evaluation Preparation:

Setup: Ensure that all materials required in the Conditions statement are available to the soldier.
 Evaluate this task during individual training.

Brief the Soldier: "You must prepare your instrumental part to ensure that you can perform all musical indicators correctly. Performance errors will be detected, isolated, and analyzed. Performance will be repeated until all errors have been corrected."

Performance Measures

	<u>GO</u>	<u>NO GO</u>
1. Performed assigned part.	—	—
a. The task is completed if all performance indicators were played correctly.		
b. Continued to step three if any performance indicators were played incorrectly.		
2. Isolated performance error.	—	—
3. Analyzed performance error.	—	—
4. Corrected performance error.	—	—

Evaluation Guidance: Score the soldier GO if all steps are performed correctly. Score the soldier NO-GO if any step is performed incorrectly. If the soldier fails any step, explain the error to correct performance.

**Perform A Bassoon Part In A Non-Marching/Non-Ceremonial Setting At A 2.7 Performance Level
514-450-1733**

Conditions: Given an instrument, assigned music, and all the necessary accessories required to perform a bassoon part in a non-marching/non-ceremonial setting, perform individually or as a member of a musical ensemble. Tuning and musical preparation have been completed.

Standards: Performed designated selections at a 2.7 level while recognizing and responding to the conductor's directions.

Performance Steps

1. Perform a selection at the designated performance level.
 - a. Perform a selection from each of the following styles (2.7 LEVEL):
 - (1) Concert or Stage Band March
 - (2) Concert or Stage Band Popular Literature
 - (3) Concert or Stage Band Show Tune
 - (4) Swing/Bop
 - (5) Concert Band Transcription of an Orchestral Piece
 - (6) Funk/Soul/Blues
 - (7) Latin: Afro-Cuban (Cha-Cha, Rumba, Mambo); Brazilian (Bossa, Samba)
 - (8) Pop/Rock
 - (9) Ballad
 - (10) Hymn or Chorale
 - b. Perform individual part while maintaining section balance, blend, intonation, style, articulation, rhythm and phrasing.
2. Perform according to conductor's directions:
 - a. Recognize and respond to baton or body cues.
 - b. Recognize and respond to phrasing direction.
 - c. Recognize and respond to dynamic indications.
 - d. Recognize and respond to style interpretations.

NOTE: Throughout the performance you must maintain proper military bearing and stage presence. Display confidence while remaining alert and attentive during the performance. Do not react outwardly if unexpected errors occur. Remember to react professionally to any recognition from the audience (e.g. soloist).

Evaluation Preparation:

Setup: Ensure that all materials required in the Conditions statement are available to the soldier. Evaluate this task during individual or collective training. To aid in evaluating this task, you may use a separate copy of the performer's music to mark errors or comments. Additionally, the soldier may be required to perform a separate audition in accordance with the *Auditions Standards Manual*, MUSCOLINST 1300.1 to verify musical proficiency.

Brief the Soldier: "You must perform your part as a member of a musical ensemble and correctly perform a selection from a designated musical style. You must follow all musical indicators on the assigned part, respond to the conductor's musical or verbal directions without error the first time through."

Performance Measures

GO NO GO

- | | | |
|--|---|---|
| 1. Performed a selection without error at the designated performance level IAW <i>Audition Standards Manual</i> , MUSCOLINST 1300.1. | — | — |
| 2. Performed according to conductor's directions. | — | — |

Evaluation Guidance: Score the soldier GO if all steps are performed correctly. Score the soldier NO-GO if any step is performed incorrectly. If the soldier fails any step, explain the error to correct performance.

References

Required

MUSCOLINST 1300.1

Related

TC 12-41
TC 12-42

Perform Auxiliary Percussion In A Marching/Ceremonial Setting

514-452-1712

Conditions: Given an auxiliary percussion instrument (bell lyra/glockenspiel, cymbals, and bass drum), assigned music, and all the necessary accessories, you are required to perform an auxiliary percussion part in a marching/ceremonial setting. You have prepared your part for performance.

Comment [DK9]: add a)

Standards: Performed stationary and marching movements without error.

NOTE: The asterisks (*) in this task refer to appropriate steps for stationary or seated ceremonial settings.

Performance Steps

1. Prepare for mission.
 - a. Inspect uniform required for mission.
 - b. Place music required for the mission in the correct sequence.

NOTE: When using the marching glockenspiel with harness, movements are the same as snare drum with harness, found in STP 12-02M-12-SM-TG, task # 514-452-1601, Perform A Percussion Part In A Marching/Ceremonial Setting.

Comment [DK10]: ok-You might want to word this so as to include the task and stp where found

2. Perform the following actions on command while performing on bell lyra/glockenspiel.

a. Attention: *

- (1) Place the staff in the harness socket.
- (2) Frame is held on the staff with the left hand placed above the base of the frame.
- (3) Tilt the instrument slightly forward and to your left.
- (4) Hold the mallet in your right hand.
- (5) Right arm hangs straight down without stiffness.
- (6) Keep right thumb straight along seam of trouser leg.
- (7) Right hand fingers curled around mallet with tip of the thumb touching first joint of index finger, and with the first joint of the fingers touching the trousers.

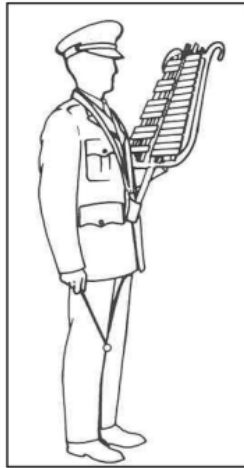

Figure 1
Bell Lyra/Glockenspiel Attention

b. Parade Rest: *

- (1) From Attention - Instrument held as in Attention.
- (2) Simultaneous movement occurs:
 - (a) Left foot moves 10 inches to left of right foot.
 - (b) Right hand moves to small of back, centered on the belt.
 - (c) Fingers and thumb extended and joined with palm facing outward while holding the mallet in a horizontal position.



Figure 2
Bell Lyra/Glockenspiel Parade Rest

- (3) At Ease:
 - (a) From Parade Rest - Stand silently, right foot remains in place.
 - (b) Other body movement is permitted.

- (4) Rest:
- (a) From Parade Rest - Place the staff on the ground in front of your body.
 - (b) Hold the upper curved frame with both hands.

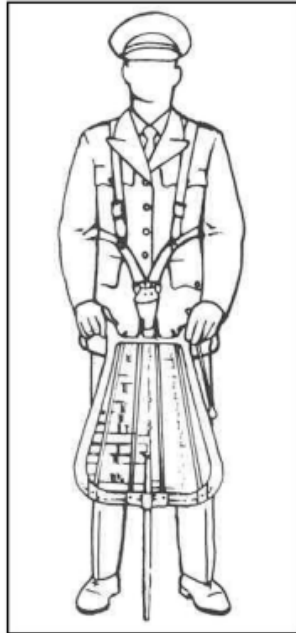

Figure 3
Bell Lyra/Glockenspiel Rest

- (5) Alternate Carry:
- (a) Hold the frame with your left hand.
 - (b) Secure the instrument horizontally under your left arm with the bars against your body.
 - (c) Hold the mallet in your right hand with your right arm hanging at your side.

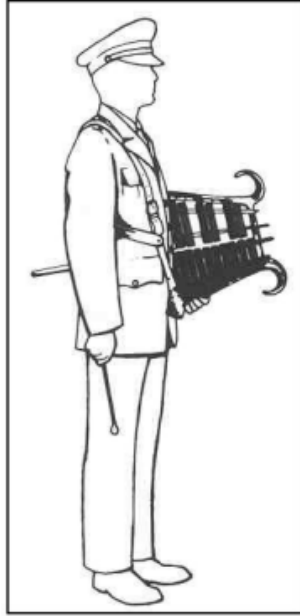

Figure 4
Bell Lyra/Glockenspiel Alternate Carry

- c. Dress Right: See FM 22-5 for specific instructions on performing this movement. *

d. Instruments Up: *

- (1) Count 1 - Ready Instrument - Move right forearm upward to hold the mallet in a vertical position at head level.



Figure 5
Bell Lyra/Glockenspiel Ready Instrument

- (2) Count 2 - No movement.
- (3) Count 3 - Prepare to Play - Move the mallet to playing position.



Figure 6
Bell Lyra/Glockenspiel Prepare to Play

e. Instruments Down: *

- (1) Count 1 - Ready Instrument - Move right forearm upward holding the mallet in a vertical position at head level.



Figure 7
Bell Lyra/Glockenspiel Ready Instrument

- (2) Count 2 - No movement.
- (3) Count 3 - Carry Position - Move your forearm downward to position of Attention as defined in paragraph 2a.

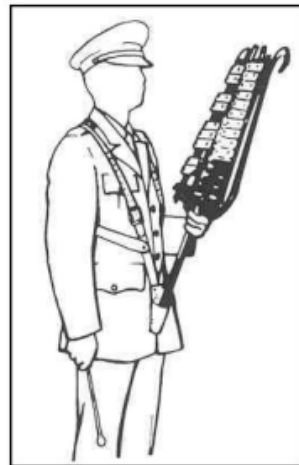

Figure 8
Bell Lyra/Glockenspiel Carry

- f. Initiate musical performance. *
- g. Stop musical performance. *
- h. Change music at the direction of the bandmaster or drum major. *
- i. Perform Sound Off chords. See FM 1-08 (FM 12-50) for specific instructions.

3. Perform the following actions on command while performing on cymbals:
 - a. Attention: *
 - (1) Hold one cymbal in each hand with the concave side facing toward your body.
 - (2) Grip cymbal straps with the thumb and four fingers of each hand.
 - (3) Hold straps with the hand. Do not place hands through the straps.
 - (4) Arms hang straight down without stiffness.

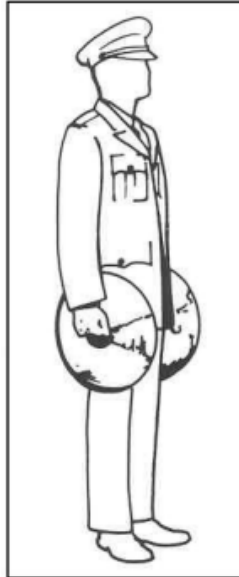

Figure 9
Cymbals Attention

- b. Parade Rest: *
 - (1) From Attention - Instrument held as in Attention.
 - (2) Simultaneous movement occurs:
 - (a) Left foot moves 10 inches to left of right foot.
 - (b) Arms remain at sides.

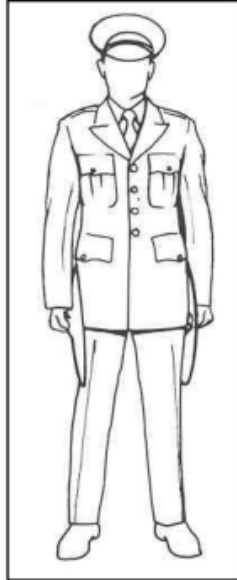

Figure 10
Cymbals Parade Rest

- (3) At Ease:
 - (a) From Parade Rest - Stand silently, right foot remains in place.
 - (b) Other body movement is permitted.

- (4) Alternate Carry/Rest:
- (a) Cymbals are fitted together.
 - (b) Right hand holds cymbals at edge between right arm and right side.
 - (c) Left hand hangs naturally at side.

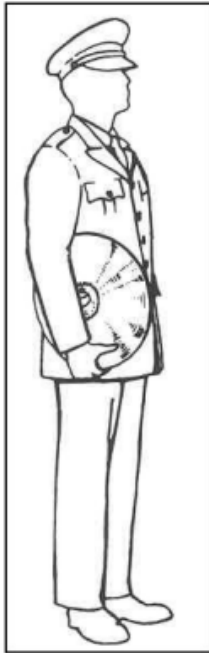

Figure 11
Cymbals Alternate Carry/Rest

- c. Dress Right: See FM 22-5 for specific instructions on performing this movement. *

d. Instruments Up: *

- (1) Count 1 - Ready Instrument - Raise cymbals to chest level with concave sides facing together. Touch cymbal edges to shoulder front.

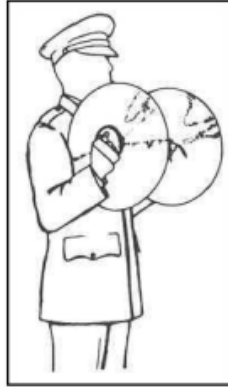

Figure 12
Cymbals Ready Instrument

- (2) Count 2 - No movement.
- (3) Count 3 - Prepare to Play - Move cymbals forward, tilting top edge of dominant hand cymbal slightly toward the other. Raise the non-dominant hand cymbal slightly higher than the dominant hand.



Figure 13
Cymbals Prepare to Play

e. Instruments Down: *

- (1) Count 1 - Ready Instrument - Lower cymbals to chest level with concave sides facing together. Touch cymbal edges to shoulder front.

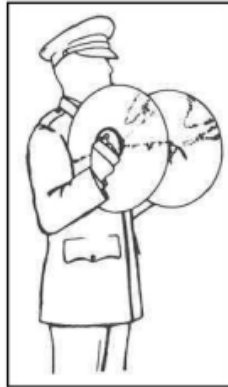

Figure 14
Cymbals Ready Instrument

- (2) Count 2 - No movement.
- (3) Count 3 - Carry Position - Hold cymbals with the concave sides facing towards your body. Arms hang straight down without stiffness



Figure 15
Cymbals Carry Position

- f. Initiate musical performance. *
- g. Stop musical performance. *
- h. Change music at the direction of the bandmaster or drum major. *
- i. Perform Sound Off chords. See FM 1-08 (FM 12-50) for specific instructions.

4. Perform the following actions on command while performing on bass drum:
 - a. Attention: *
 - (1) Hook the instrument to the bass drum harness.
 - (2) Adjust it to comfortable position in front of your body.
 - (3) Hold the mallet(s) along the side(s) of your body.
 - (4) Both arms should hang straight without being stiff.
 - (5) The mallets should point down.

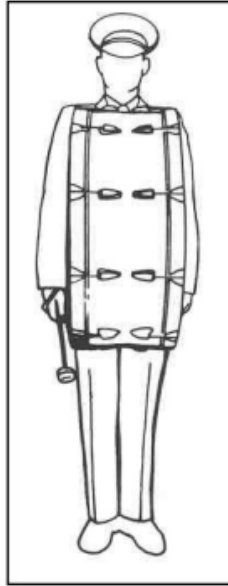

Figure 16
Bass Drum Attention

b. Parade Rest: *

- (1) From Attention - Bass drum held as in Attention.
- (2) Simultaneous movement occurs:
 - (a) Left foot moves 10 inches to left of right foot.
 - (b) Place both your hands at the small of your back centered on your belt.
 - (c) Hold mallets, using both hands, in a horizontal position.
 - (d) Palms face outward.

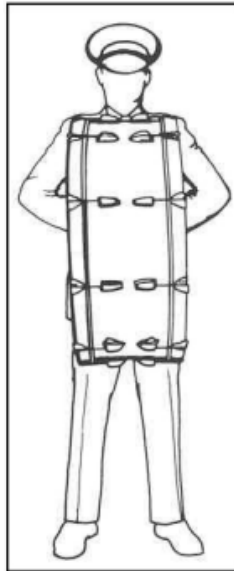

Figure 17
Bass Drum Parade Rest

- (3) At Ease:
 - (a) From Parade Rest - Stand silently, right foot remains in place.
 - (b) Other body movements is permitted.

- (4) Rest:
- (a) Unhook the instrument.
 - (b) Place it on the ground directly in front of your feet.
 - (c) Place mallets in an easily accessible position on top of drum shell.
 - (d) Place both your hands at the small of your back centered on your belt.

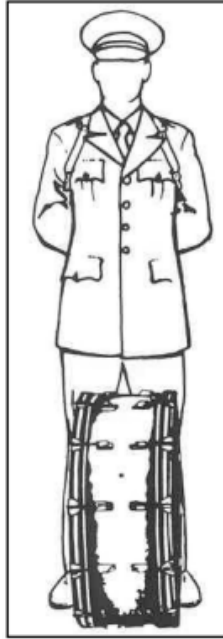

Figure 18
Bass Drum Rest

c. Dress Right: See FM 22-5 for specific instructions on performing this movement.*

Comment [DK11]: add an *

d. Instruments Up: *

- (1) Count 1 - Ready Instrument - Move forearms upward to hold mallet(s) in a vertical position at head level.

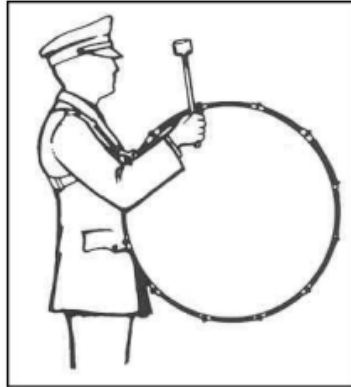

Figure 19
Bass Drum Ready Instrument

- (2) Count 2 - No movement.
- (3) Count 3 - Prepare to Play - Move mallet(s) upward to the playing position.



Figure 20
Bass Drum Prepare to Play

e. Instruments Down: *

- (1) Count 1 - Ready Instrument - Move arms upward to hold the mallets in a vertical position at head level.

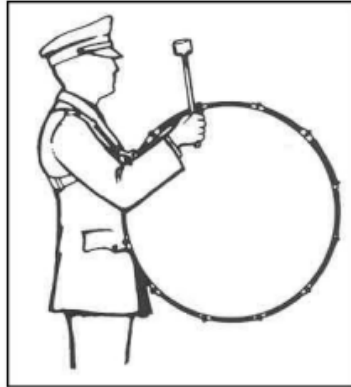

Figure 19
Bass Drum Ready Instrument

- (2) Count 2 - No movement.
- (3) Count 3 - Carry Position - Move arms downward, as in Attention.

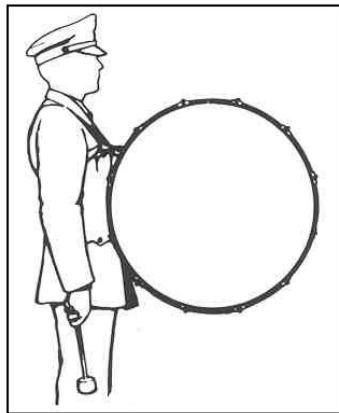

Figure 21
Bass Drum Carry Position

- f. Initiate musical performance. *
- g. Stop musical performance. *
- h. Change music at the direction of the bandmaster or drum major. *
- i. Perform Sound Off chords. See FM 1-08 (FM 12-50) for specific instructions.

5. Execute all marching movements listed below correctly (not playing) on command:
 - a. Forward March from Halt
 - b. Mark Time
 - c. Forward March from Mark Time
 - d. Half Step
 - e. Forward March from Half Step
 - f. Left Turn
 - g. Right Turn
 - h. Alternate Left Turn
 - i. Alternate Right Turn
 - j. Reversible Countermarch
 - k. Non-reversible Countermarch
 - l. Guide Around
6. Execute all marching movements in step five of this task on command while playing.
7. Execute instruments up, instruments down, initiate musical performance, and stop musical performance, while executing any of the marching movements in step five.
8. Execute Sound Off sequence correctly per FM 1-08 (FM 12-50) paragraph B-88.
9. Execute appropriate steps from this task (denoted by the asterisk) for stationary or seated ceremonial settings.

NOTE: Throughout the performance you must maintain proper military bearing and stage presence. Display confidence while remaining alert and attentive during the performance. Do not react outwardly if unexpected errors occur. Remember to react professionally to any recognition from the audience (e.g. soloist).

Evaluation Preparation:

Setup: Ensure that all materials required in the Conditions statement are available to the soldier. Evaluate this task during collective training or actual mission performance.

Brief the Soldier: "You must correctly execute all actions while performing your assigned part."

Performance Measures

	<u>GO</u>	<u>NO GO</u>
1. Prepared for mission.	—	—
2. Executed the following actions without error on command:	—	—
a. Attention *		
b. Parade Rest/At Ease *		
c. Dress Right *		
d. Instruments Up * (Vocal, mace, or baton command and roll-off)		
e. Instruments Down * (Vocal, mace, or baton command)		
f. Initiated musical performance * (Vocal, mace, or baton command)		
g. Stopped musical performance * (Mace or baton command)		
h. Changed music when directed *		
i. Performed Sound Off chords		

- | | |
|--|------------|
| <p>3. Executed all marching movements listed below correctly (not playing) on command:</p> <ul style="list-style-type: none"> a. Forward March from Halt b. Mark Time c. Forward March from Mark Time d. Half Step e. Forward March from Half Step f. Left Turn g. Right Turn h. Alternate Left Turn i. Alternate Right Turn j. Reversible Countermarch k. Non-reversible Countermarch l. Guide Around | <p>— —</p> |
| <p>4. Executed all marching movements in step three on command while playing.</p> | <p>— —</p> |
| <p>5. Executed steps 2d, 2e, 2f, and 2g while executing any of the marching movements in step three.</p> | <p>— —</p> |
| <p>6. Executed Sound Off sequence correctly per FM 1-08 (FM 12-50) paragraph B-88.</p> | <p>— —</p> |
| <p>7. Executed appropriate steps from this task (denoted by the asterisk) for stationary or seated ceremonial settings.</p> | <p>— —</p> |

Evaluation Guidance: Score the soldier GO if all steps are performed correctly. Score the soldier NO-GO if any step is performed incorrectly. If the soldier fails any step, explain the error to correct performance.

References

Required
 FM 1-08
 FM 22-5

Related
 AR 600-25
 TC 12-41
 TC 12-42

Construct Bassoon Reeds
514-450-1402

Conditions: Given all materials/equipment listed below, and a requirement to create a bassoon reed.

1. Shaped, folded reed blanks
2. Needle-nosed pliers
3. Polyester/nylon upholstery thread (several types available)
4. Mandrels (short and long)
5. Billot or cutting block
6. Plaque
7. Exacto knife or razor blade
8. Soaking bowl
9. Ruler with inches/metric measurements
10. Clear nail polish
11. #22 soft brass wire
12. Good lighting
13. Reed knives and sharpening equipment
14. Magnifying lenses to be worn(nice to have)

Standards: Completed all the steps necessary to create a bassoon reed.

Performance Steps

1. Obtain all materials/equipment listed in the Conditions statement to create a bassoon reed.
2. Perform steps required for tying a bassoon reed.

Comment [DK12]: not needed as you only called it 'equipment' in the conditions statement.

Comment [DK13]: Also not needed. If you want to leave it, it should probably be part of the sentence and not in parentheses.

NOTE: Making blanks from raw cane will not be covered in this publication. There are several sources available and several will be addressed in the Reference section.

- a. Inspect reed material using pre-cut reed blanks.
 - (1) Look for straight grain and good yellow color.
 - (2) Look for any splits or cracks in the reed blank.
- b. Forming and tying the bassoon reed blank.
 - (1) Fold the blank and place two turns of soft brass wire 1-3/8 inches from the tip of the reed.
 - (2) Ensure blades are evenly aligned before tightening the wire.
 - (3) Tighten the wire by drawing it out and twisting with the pliers.
 - (4) Cut the wire to 1/8 inch.
 - (5) Soak the blank in warm water for approximately 15 minutes.
 - (6) Begin tightly wrapping the reed with soaked butcher's twine approximately 1/4 inch above the wire downwards to the base.
 - (7) Insert the long mandrel 1/2 of an inch into the base of the reed, kneading the flat sides with pliers.
 - (8) Gradually insert the mandrel to a depth of 3/4 of an inch by rotating it in both directions.
 - (9) Continue kneading the reed with pliers until the mandrel is inserted deep enough to cause the base of the reed to become circular.
 - (10) Remove the twine and insert the mandrel until the base of the reed begins to separate.
 - (11) Place the second wire 3/8 inch below the first wire and tighten from the opposite side, cutting this wire to 1/8 inch.

Comment [DK14]: May want to just say 'There are several sources available in the References section of this STP' Also, this and the previous sentence should probably be a NOTE:

Comment [DK15]: Ensure?

Comment [DK16]: Blank?

Comment [DK17]: 1/2 what? Halfway, 1/2 inch....?

- (12) Place the third wire $\frac{1}{2}$ of an inch below the second wire and tighten from the opposite side, cutting this wire to $\frac{1}{8}$ inch in length.

Comment [DK18]: Again I'm not sure what $\frac{1}{2}$ you are referring to.

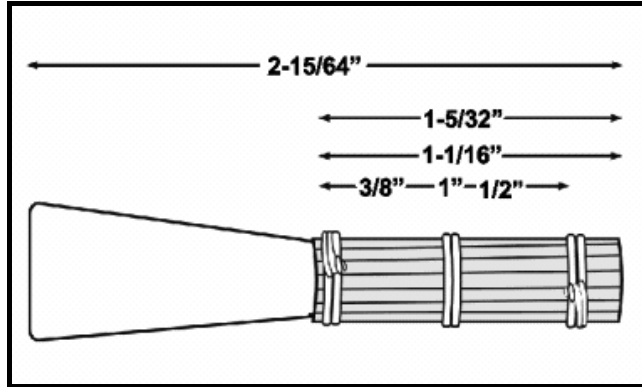

Figure. 1
Bassoon Reed Wire Placement

- (13) Remove mandrel and tighten the second and third wires.
 (14) Sand the edges and blades lightly.
 (15) Blank is formed and now ready for preliminary shaping.

3. Perform steps for preliminary shaping of a bassoon reed.
- Insert the mandrel and using a razor blade, circumscribe the blank $\frac{1}{16}$ of an inch above the first wire.
 - Cut the bark back to the circumscribed line to not more than $\frac{1}{64}$ inch depth, smoothing any imperfections.
 - Ensure sides are straight from the first wire to the tip using a ruler.

Comment [DK19]: Not really needed. If you want to keep it, it should probably be (15) and say something like 'reed blank is now ready for preliminary shaping' as that is the next step.

Comment [DK20]: May read better as 'Ensure sides are straight from the first wire to the tip using a ruler.'

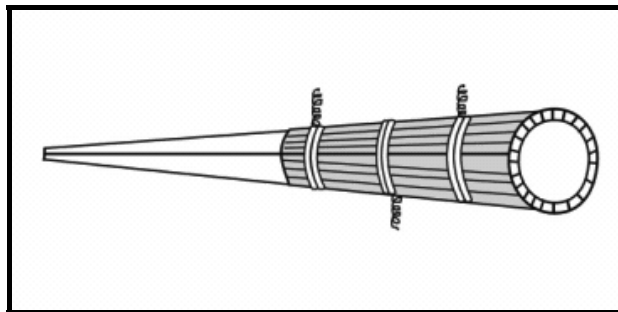

Figure. 2
Bassoon Reed Proper Aperture

- Ensure correct location of the backbone or spine of the reed with a ruler, checking for gradual removal of material from the base to within $\frac{1}{8}$ inch of the tip.
- Allow to air dry overnight.
- Insert the mandrel loosely and tighten the second and third wires, cutting these wires to $\frac{1}{8}$ inch.

Comment [DK21]: Ensure

Comment [DK22]: do they know what 'correct formation' is? I'm not sure I do from the task so far. Or is the correct formation the checking for the gradual removal of material from the base to within $\frac{1}{8}$ inch of the tip?

Comment [DK23]: This should probably be it's own step (g)

- g. Bend the second wire downward along the blank.
- h. Bend the third wire upward along the blank.
- i. Ensure base ends are even by either cutting or using a file.
- j. Permanently secure the reed by wrapping with string, forming the "Turk's Head" centered over the third (base end) wire and continue wrapping upward to the second (middle) wire.

Comment [DK24]: Ensure

Comment [DK25]: should have big h if it's a title of sorts.

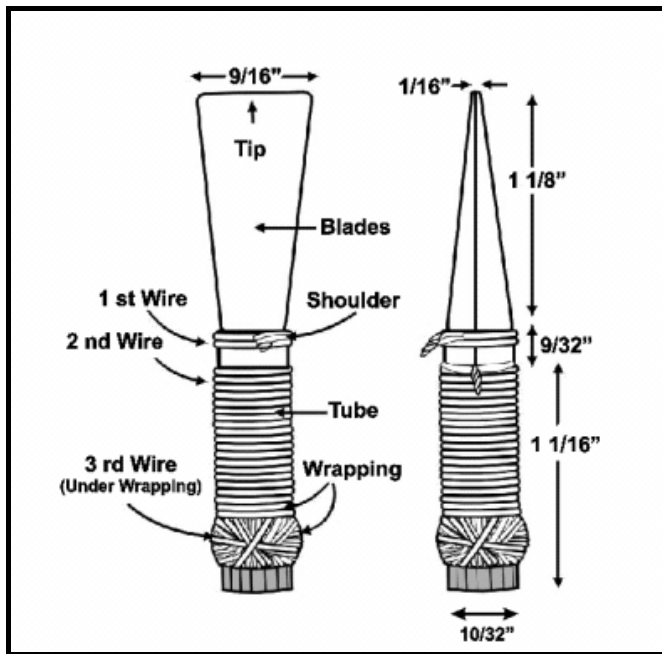

Figure. 3
Bassoon Reed Components And Dimensions

- k. Several methods can be used to "seal" the reed base:
 - (1) Plastic dip
 - (2) Nail polish
 - (3) Hyplar coating
 - (4) Shrinkable plastic tubing
- l. Ensure a continual taper bore from the base of the reed to the first wire by careful reaming.
- 4. Perform steps required for final shaping of a bassoon reed.
 - a. Soak the reed for 20 minutes in warm water.
 - b. Insert the blank onto the mandrel and begin removing material with a moistened profiling file.
 - c. Ensure that you work from the base to the tip and achieve a fine taper towards the tip.
 - d. Using a cutting block, cut the blank, while wet, at 1-3/16 inches from the top wire.
 - e. Cut off small corners of the tip (approximately 1/64 inch).
 - f. The entire reed should be 2-3/16 inches in length.
 - g. Check for tip opening symmetry (more material at the center than at the sides).
 - h. Insert the short mandrel and the plaque, and begin using the trimming knife to work from the base to the tip, perfecting a half-moon profile.
 - i. Smooth the reed with a fine file and sandpaper.
 - j. Carefully thin the tip to a thickness on approximately 1/32 of an inch.
 - k. Check for a symmetrical tip opening, so that the blades do not touch except at the sides.

Comment [DK26]: ensure

Comment [DK27]: ensure

- I. Check for air tightness by blocking the base of the reed with a moistened fingertip and sucking out the air. If airtight, the reed will not pop open in less than 2 seconds.
- 5. Perform tests for leaks and successful "crow" of a bassoon reed.
 - a. Insert the reed in the mouth up to the first wire and blow, listening for several pitches or overtones to be produced rather than a single pitch.
 - b. Perform any needed wire adjustments (not the third or base wire) to ensure proper tip opening.
 - c. If any additional material is to be removed, always remove in a straight line from the base of the reed to the tip and follow the grain of the cane.

Comment [DK28]: ensure

NOTE: All reed measurements are approximate as everyone has their own ideas on reed making. The information presented here is a compilation of various sources. There are several publications detailing the actual techniques used to create and fine tune a bassoon reed. This publication lists several sources in the References section.

Comment [DK29]: this should read the same as the 02h book.

Evaluation Preparation:

Setup: Ensure that all materials/equipment required in the Conditions statement are available to the soldier. Evaluate this task during individual training.

Brief the soldier: "You must complete all the steps necessary to create a bassoon reed."

Performance Measures

	<u>GO</u>	<u>NO GO</u>
1. Obtained all materials/equipment required to create a bassoon reed.	—	—
2. Performed steps required for tying a bassoon reed.	—	—
3. Performed steps required for preliminary shaping of a bassoon reed.	—	—
4. Performed steps required for final shaping of a bassoon reed.	—	—
5. Performed tests for leaks and successful "crow" of a bassoon reed.	—	—

Comment [DK30]: Not needed. Should be worded like the conditions and performance measures statement.

Evaluation Guidance: Score the soldier GO if all steps are performed correctly. Score the soldier NO-GO if any step is performed incorrectly. If the soldier fails any step, explain the error to correct performance.

References

Required

Related

Perform Player Maintenance On A Bassoon
514-450-1401

Conditions: Given a bassoon, all maintenance equipment and supplies listed below, and a requirement to perform player maintenance on a bassoon.

1. Clean surface large enough to place the disassembled instrument
2. Mild dish soap in tub of lukewarm water
3. Soft, clean cloth
4. Small piece of cheese cloth
5. Weighted cloth swab
6. Oil swab
7. Bocal and tenon wrapping string
8. Pipe cleaners or cotton tip swabs
9. Toothpicks
10. Nongummed, absorbent cigarette rolling paper
11. Bassoon bocal brush
12. Key brush
13. Needle oiler with woodwind key oil
14. Woodwind bore oil
15. Cork grease
16. Paraffin wax
17. Jewelers screwdriver set

Standards: Completed all the steps necessary to perform player maintenance on a bassoon.

Performance Steps

1. Disassemble instrument.
 - a. Remove reed from bocal and store in reed case.
 - b. Remove bocal from wing, or tenor joint.
 - (1) Grasp bocal near corked end.
 - (2) Pull out using a slight twisting motion, being careful not to rip whisper key pad.
 - c. Remove bell from bass joint, ensuring bridge keys are clear of each other.
 - d. Release joint lock between bass joint and tenor joint.
 - e. Remove bass joint from boot joint using a short twisting, pulling motion.
 - f. Similarly remove tenor joint from boot joint ensuring bridge keys are free of each other.
2. Inspect the instrument and identify all deficiencies.
 - a. Body:
 - (1) Check for cracks in wood instruments. Look through bore and on outside body.
 - (2) Check joints for solid fit.
 - b. Key assemblies:
 - (1) Check for sticking, rubbing, and clicking.
 - (2) Check for bent keys, rods, and posts.
 - (3) Ensure springs are properly placed.
 - (4) Check bridge for proper function and alignment.
 - (5) Ensure screws are properly set.

Comment [DK31]: Not needed because you then tell them to use a slight twisting motion.

Comment [DK32]: Add a comma

- c. Pads/Corks:
- (1) Check for looseness, dryness, rips, tears, holes, and cleanliness. Comment [DK33]: add a comma
 - (2) Check for proper set against tone hole.
 - (3) Check for seal of individual joints.
 - (a) Close the bottom of the tenon with palm of hand and cover all tone holes.
 - (b) Blow through the top of the tenon to listen and feel for leaks.
 - (c) Draw air through the top of the tenon to create a vacuum and to listen and feel for leaks.
 - (d) The boot joint will require that you block one side with your cheek while drawing air from the other side to create a vacuum and to listen and feel for leaks.
3. Maintain the instrument.
- a. Reed:
 - (1) Run lukewarm water through reed.
 - (2) Store in reed case.
 - b. Bocal:
 - (1) Run lukewarm, soapy water through bocal.
 - (2) Clean with flexible bocal brush.
 - c. Whisper Key:
 - (1) Clean pinhole with toothpick.
 - (2) Never use any type of metal pin or needle as they may damage the opening.
 - d. Key Assemblies:
 - (1) Use a key brush, cotton swab, or pipe cleaner around keys, posts, and tone holes. Comment [DK34]: add a comma
 - (2) Do not allow exposed pipe cleaner wire to damage pads or corks. Comment [DK35]: add a comma
 - (3) Do not use silver polish on tarnished keys.
 - (4) Apply small drop of key oil to key mechanisms using needle oiler.
 - (a) Touch tip of oiler to each point of mechanism where keys meet posts, or keys meet other keys.
 - (b) Remove excess oil with pipe cleaner or cotton swab.
 - (c) Keep key oil away from pads and corks.
 - (5) Oil twice monthly or more frequently as needed.
 - e. Pads:
 - (1) Use cheesecloth or absorbent paper between pad and tone hole.
 - (a) Gently close pad cup.
 - (b) Draw cloth or paper from under pad to remove residue.
 - (2) Clean as needed.
 - f. Bore:
 - (1) Swab boot, tenor, and bass joint with a dry, weighted swab after each use. Comment [DK36]: add a comma
 - (2) The bell and long joint do not need to be swabbed after each use, as they do not come in contact with moisture under normal playing conditions.
 - (3) Use a dry, weighted swab when needed.
 - (4) Do not swab bore oil through the bassoon.
 - (5) Never allow oil to contact rubber lined parts of the bore.
 - g. Tenons:
 - (1) Lubricate corks with cork grease.
 - (2) If tenon is wrapped with thread, do not use cork grease. Use paraffin wax as a lubricant.
 - (3) Lubricate as needed.
 - h. Wipe instrument keys with clean, soft cloth after each use.
4. Assemble instrument and check playing condition.
- a. Ensure accountability of all parts.
 - b. Check whisper key for proper alignment.
 - c. Ensure proper working condition.

5. Store instrument.
 - a. Instrument must be dry before storing in its case.
 - b. Store free from temperature and humidity extremes.
 - (1) Best temperature range is 55-75 degrees Fahrenheit.
 - (2) Best humidity level is 50%.
 - c. Inspect case for serviceability.
 - d. Keep accessories in proper compartments, or stored separately.
 - e. Inspect for serviceability every three months.
6. Perform emergency repairs as required.
 - a. Player repairs should be limited to emergency measures. Allow professional repair technicians to perform all other repairs.
 - b. Pads may be temporarily repaired using the following methods.
 - (1) Heat the pad cup with a lighter to melt dry glue and replace pad.
 - (2) Use a low temperature glue stick to hold pad in pad cup.
 - c. Key regulation cork may be temporarily replaced with contact cement.
 - d. Use a crossed pattern to properly space tenon strings.
 - (1) To tighten joint fit - Evenly weave additional tenon string around appropriate tenon and rewax string.
 - (2) To loosen joint fit - Evenly unwrap tenon string from appropriate tenon and rewax string.
 - e. Instrument should be inspected annually by professional repair technician.

Comment [DK37]: may want to say 'using the following methods'

Evaluation Preparation:

Setup: Ensure that all materials required in the Conditions statement are available to the soldier. Evaluate this task during individual training.

Brief the soldier: "You must complete all the steps necessary to perform player maintenance on a bassoon."

Performance Measures

	<u>GO</u>	<u>NO GO</u>
1. Disassembled the instrument.	—	—
2. Inspected the instrument.	—	—
3. Identified all deficiencies.	—	—
4. Maintained the instrument as indicated.	—	—
5. Assembled instrument.	—	—
6. Checked playing condition.	—	—
7. Stored the instrument properly.	—	—
8. Performed emergency repairs as required.	—	—

Evaluation Guidance: Score the soldier GO if all steps are performed correctly. Score the soldier NO-GO if any step is performed incorrectly. If the soldier fails any step, explain the error to correct performance.

References

Required

Related

Subject Area 2: Administrative Tasks

File Records
121-004-1228

Conditions: NOTE: For ease of reading, the term "document" in this task summary refers not only to documents, but also to such items as correspondence, messages, military orders, completed forms, and records.

Given. Documents and correspondence which require filing and access to: a. AR 25-400-2. b. AR 25-55. c. AR 380-5. d. AR 25-50. e. Approved list of file numbers. f. Existing files. g. Standard office equipment.

Standards: File the documents and correspondence IAW AR 25-400-2.

Evaluation Preparation: Supervisors may evaluate task performance by two methods. They can have the soldier perform the task on the job or take the performance test. The supervisor may evaluate the soldier by either or both of these methods. a. To evaluate a soldier's performance on the job, the soldier should perform the task, using the materials which appear in the above CONDITIONS statement. When the soldier completes the task, the supervisor uses the evaluation guide to score the soldier PASS (P) or FAIL (F) on each performance measure. b. If the soldier does not perform the task on the job, the supervisor may conduct an evaluation by having the soldier take the performance test.

Performance Measures	<u>GO</u>	<u>NO GO</u>
1. Review and use the approved list of file numbers to determine the content of the files when filing or retrieving documents from the files.	—	—
2. Check the document to determine that it is a complete action.	—	—
3. Obtain any missing portions of the document from the office that prepared the last action.	—	—
4. Remove any unnecessary material from the document, such as--	—	—
a. Extra copies.		
b. Notes/comments.		
c. Routing (transmittal) slips.		
d. Cover sheets.		
e. Paper clips.		
5. Assemble and correctly fasten the document in proper order for filing IAW AR 25-400-2 and AR 25-50.	—	—
6. Determine the correct file number of the document being filed by:	—	—
a. Subject.		
b. Action/content.		
7. Enter the file number in the correct position on the document being filed if necessary.	—	—

- 8. Place the document in the correct file folder according to the filing category or sequence being used. — —
 - a. Chronological by date (latest date in front).
 - b. Numerical (social security number, serial number, etc.) (ascending - front to back).
 - c. Alphabetical by subject title or by name (person, place, or organization).
- 9. File classified documents separately from unclassified documents in security containers. — —
- 10. Retrieve document properly from the files and substitute it with a correctly prepared charge-out record. — —

Evaluation Guidance: Score a GO if the soldier passes (P) all applicable performance measures. Score a NO GO if the soldier fails (F) any performance measure. Show the soldier what was done wrong on any failed performance measure and how to do it correctly.

References

Required
AR 25-50
AR 380-5

Related

Post Regulations And Directives
121-004-1515

Conditions: *NOTE: For ease of reading, the terms regulations and directives will be referred to as publication(s) in this task summary.

Given. A basic publication*, a change to that publication, and access to: a. DA Pam 310-13. b. Standard office supplies and equipment.

Standards: Post the change to the basic publication IAW DA Pam 310-13.

Evaluation Preparation: Supervisors may evaluate task performance by two methods. They can have the soldier perform the task on the job or take the performance test. The supervisor may evaluate the soldier by either or both of these methods. a. To evaluate a soldier's performance on the job, the soldier should perform the task, using the materials which appear in the above CONDITIONS statement. When the soldier completes the task, the supervisor uses the evaluation guide to score the soldier PASS (P) or FAIL (F) on each performance measure. b. If the soldier does not perform the task on the job, the supervisor may conduct an evaluation by having the soldier take the performance test.

****NOTE:** The posting instructions in DA Pam 310-13 apply to Department of the Army publications, and the principles can also be applied to agency, command, or local publications.

Performance Measures	<u>GO</u>	<u>NO GO</u>
1. Review the publication change instructions to determine the type of change to be made.	—	—
a. Penciled annotation to a bound publication.		
b. Rescission of an existing publication.		
c. Supersession of an existing publication.		
d. Loose-leaf change.		
2. Post changes to a bound publication correctly, using penciled annotations.	—	—
a. Less than three lines deleted.		
b. Three or more lines deleted.		
c. Material added.		
d. Minor change.		
e. Repetitive change.		
f. Rescission (portion of a publication, such as a chapter, section, paragraph, etc.).		
g. Supersession (portion of a publication, such as a chapter, section, paragraph, etc.).		
h. Change authority notation (adjacent to the change).		
i. Effective date notation (adjacent to the change).		
j. "Posting" information entered on the change instruction sheet.		
k. File change instruction sheet in the front of the publication.		
3. Post an existing publication (and changes) correctly with a rescission.	—	—
a. Identify the publication to be rescinded.		
b. Remove the publication from the file.		
c. Destroy the publication unless it is required for further reference.		
d. Post the rescission information as required.		
4. Post an existing publication (and changes) correctly with a supersession.	—	—
a. Identify the publication to be superseded.		
b. Remove the publication from the file.		
c. Destroy the publication unless it is required for further reference.		
d. Post the supersession information as required.		
5. Post an existing publication (and changes) correctly with a loose-leaf change.	—	—
a. Remove the pages containing incorrect/outdated/rescinded information (IAW the change instruction sheet).		
b. Insert the new/replacement pages containing correct/updated information IAW the change instruction sheet.		
c. Enter the required "posting" information to the change instruction sheet.		
d. File the change instruction sheet in the front of the publication.		
6. Post an existing publication (and changes) correctly with a change received by message.	—	—
a. Amend the publication as directed by the message.		
b. Enter the change authority notation (adjacent to the change).		
c. File the copy of message in the front of the publication.		

Evaluation Guidance: Score a GO if the soldier passes (P) all applicable performance measures. Score a NO GO if the soldier fails (F) any performance measure. Show the soldier what was done wrong on any failed performance measure and how to do it correctly.

**Safeguard "For Official Use Only" (FOUO) Material
121-030-1507**

Conditions: Given. The requirement to safeguard FOUO material and access to: a. AR 25-55. b. AR 25-11. c. AR 25-400-2. d. DA Label 87. e. FOUO material. f. Standard office supplies and equipment.

Standards: Protect FOUO material IAW AR 25-55.

Evaluation Preparation: Supervisors may evaluate task performance by two methods. They can have the soldier perform the task on the job or take the performance test. The supervisor may evaluate the soldier by either or both of these methods. a. To evaluate a soldier's performance on the job, the soldier should perform the task, using the materials which appear in the above CONDITIONS statement. When the soldier completes the task, the supervisor uses the evaluation guide to score the soldier PASS (P) or FAIL (F) on each performance measure. b. If the soldier does not perform the task on the job, the supervisor may conduct an evaluation by having the soldier take the performance test.

Performance Measures

	<u>GO</u>	<u>NO GO</u>
1. Ensure that the material requires FOUO protective marking for one or more of the reasons cited in the Freedom of Information Act (FOIA), exemptions 2 through 9, contained in AR 25-55.	—	—
2. Verify that the FOUO material is properly marked. <ul style="list-style-type: none"> a. Permanently bound document. b. Document not permanently bound. 	—	—
3. Safeguard FOUO material properly during duty and non-duty hours.	—	—
4. Attach or remove a DA Label 87 as applicable.	—	—
5. Release FOUO material only to authorized agencies and personnel.	—	—
6. Verify that the FOUO material is marked with the required exemption statement for material being sent outside the Department of Defense (DoD), or as otherwise required by Army regulation.	—	—
7. Transport FOUO material properly by distribution or mail, or properly send FOUO material by electronically transmitted message.	—	—
8. Annotate material properly to terminate the FOUO protective marking.	—	—
9. Dispose of record/nonrecord copies of FOUO material properly.	—	—

Evaluation Guidance: Score a GO if the soldier passes (P) all applicable performance measures. Score a NO GO if the soldier fails (F) any performance measure. Show the soldier what was done wrong on any failed performance measure and how to do it correctly.

References

Required

Related

AR 105-31

Subject Area 3: Tactical Tasks

Operate A Dismount Point
191-376-4108

Conditions: Given a crew-served weapon, individual weapon, ammunition, flashlight with filtered lens, night-vision devices, signs, and instructions from your team leader.

Standards: Do all necessary steps to ensure only authorized personnel enter the CP area.

Evaluation Preparation: Setup: Because you will need a dismount point to evaluate this task, it is best to do it during a training exercise. Use a three-member team so that you can evaluate three soldiers at a time. Give the soldiers an opportunity to work at each position so you can evaluate them on all performance measures. You will also need extra personnel, fully equipped, to provide traffic at the dismount point.

Brief Soldier: Tell soldiers that they will be expected to install and remove equipment for each position and that they should take the necessary steps to control traffic.

Performance Measures

	<u>GO</u>	<u>NO GO</u>
1. Establishes the defensive position.	—	—
a. Establish fields of fire.		
b. Emplace the crew-served weapon.		
c. Maintain routine duty assigned by the team leader.		
2. Sets up communications.	—	—
3. Marks the light line IAW team leader's instructions.	—	—
4. Operates the dismount point.	—	—
a. Use hand, arm, and flashlight signals.		
b. Stop vehicles at the dismount point.		
c. Ensure that OPSEC procedures are enforced.		
d. Identify all personnel for authorized entry into CP area IAW unit SOP. If passengers are authorized, allows passengers to dismount and enter the CP area. Provides information on enemy activity and locations of other facilities.		

NOTE: Inspect packages, briefcases, and vehicle loads entering the area if required by unit SOP.

- e. Prevent civilian traffic and refugees from entering the CP area.
- f. Control stragglers IAW unit SOP.

Evaluation Guidance: Score the soldier GO if all steps are passed (P). Score the soldier NO-GO if any step is failed (F). If the soldier fails any step, show what was done wrong and how to do it correctly.

Control Access to a Restricted Area
514-441-1201

Conditions: Given an individual weapon, ammunition, a protective mask, a flashlight with filtered lens, an access roster, access badges, an access control log, a communication device, a map of the restricted area, and instructions from your team leader.

Standards: Completed all necessary steps to ensure that only authorized personnel entered the restricted area.

Performance Steps

1. Allow one person at a time into the access tent or access control area.
2. Ask to see the picture identification card of the person requesting access.
3. Check the name on the identification card against the access roster and the picture against the requester's physical appearance.
 - a. Proceed to task step 4 if the name on the identification card appears on the access roster, and the picture matches the requester's physical appearance.
 - b. Refuse entry to any personnel whose name does not appear on the access roster, or whose picture does not match their physical appearance, and contact your team leader to request further instructions.
4. Assign the next available access badge to the person requesting access.
5. Issue the access badge to the requester.
 - a. Copy the badge control number onto the access control log.
 - b. Copy the requester's social security number from the identification card onto the access control log.
 - c. Enter the requester's destination into the access control log.
 - d. Enter the time the badge was issued into the access control log.
 - e. Instruct the requester to print and sign his/her name on the appropriate blocks in the access control log.
 - f. Retain the requester's identification card until the log is completely filled out.
6. Grant the requester access to the restricted area.
7. Direct personnel to their destination within the secure area if such information is requested.
8. Enforce noise, light, and litter discipline at all times. (STP 21-1-SMCT 071-331-0815 Practice noise, light, and litter discipline.)
9. Collect all badges from personnel leaving the restricted area, and enter the time of return into the access control log.
10. Request periodic updates and/or clarification on the established rules of engagement from your team leader.

Evaluation Preparation:

Setup: Ensure that all materials required in the Conditions statement are available to the soldier. This task is best evaluated during collective training. Evaluate the individual soldier rather than the team as a whole. Before the evaluation starts, tell the examinee what the rules of engagement will be. Rules of engagement vary according to the tactical situation and must be obtained from the Band Commander prior to task evaluation.

Brief the Soldier: "You must correctly execute all performance measures in sequence while employed as part of a team providing access control to a restricted area."

Performance Measures	<u>GO</u>	<u>NO GO</u>
1. Allowed one person at a time into the access tent or access control area.	—	—
2. Identified personnel requesting access to the restricted area.	—	—
3. Processed personnel meeting access authorization criteria.	—	—
4. Granted access to authorized personnel.	—	—
5. Directed personnel granted access to their destination if requested.	—	—
6. Collected badges when personnel left the restricted area.	—	—
7. Enforced noise, light, and litter discipline.	—	—
8. Requested updates and/or clarification on the established rules of engagement.	—	—

Evaluation Guidance: Score the soldier GO if all steps are performed correctly. Score the soldier NO-GO if any step is performed incorrectly. If the soldier fails any step, explain the error to correct performance.

References

Required

FM 19-30
STP 21-1-SMCT

Related

Perform Perimeter Security

514-441-1202

Conditions: Given an individual weapon, ammunition, a protective mask, a flashlight with filtered lens, night vision goggles, a communication device, instructions from your team leader and the requirement to perform perimeter security.

Standards: Performed all necessary steps to ensure that your assigned area of the perimeter remained secure.

Performance Steps

1. Use priorities of force IAW established rules of engagement and rules of interaction.
2. Obtain periodic updates and/or clarification on the established rules of engagement and rules of interaction.
3. Perform surveillance of the area using visual search techniques. (STP 21-1-SMCT 071-331-0804 Perform Surveillance Without the Aid of Electronic Devices.)

4. Report status to your team leader at predetermined time intervals.
5. Deliver a report using the mnemonic S-A-L-U-T-E (Size, Activity, Location, Unit, Time, Equipment) to your team leader when enemy activity is suspected. (STP 21-1-SMCT 301-348-1050 Report Information of Potential Intelligence Value.)
6. Prevent unauthorized personnel from entering the perimeter.
 - a. Use challenge and password. (STP 21-1-SMCT 071-331-0801 Challenge Persons Entering Your Area.)
 - b. Detain any personnel attempting to gain unauthorized access to the perimeter.
 - c. Report unauthorized attempted perimeter entry to your team leader.
 - d. Follow the instructions of your team leader with regard to any detainees.
 - e. Continue the mission IAW the instructions you have been given.
7. Prevent unauthorized personnel from exiting the perimeter.
 - a. Detain EPW/CI attempting to escape from the facility.
 - b. Report the attempted escape to your team leader.
 - c. Follow the instructions of your team leader with regard to any detainees.
 - d. Continue the mission IAW the instructions you have been given.
8. Detect breaks in the perimeter, signs of tunneling, or other possible breaches.
 - a. Visually inspect fence or barrier.
 - b. Report any actual or suspected breach to your team leader.
 - c. Remain at the breach site until you receive further instructions from your team leader.
 - d. Continue the mission IAW the instructions you have been given.
9. Maintain noise, light, and litter discipline at all times. (STP 21-1-SMCT 071-331-0815 Practice Noise, Light, and Litter Discipline.)

Evaluation Preparation:

Setup: Ensure that all materials required in the Conditions statement are available to the soldier. This task is best evaluated during collective training. Evaluate the individual soldier rather than the team as a whole. Before the evaluation starts, tell the examinee what the rules of engagement and/or the rules of interaction will be. Rules of engagement and/or rules of interaction vary according to the tactical situation and must be obtained from the Band Commander prior to task evaluation.

Brief the Soldier: "You must correctly execute all performance measures while employed as part of a team providing perimeter security. Performance measures do not have to be performed in sequence."

Performance Measures

	<u>GO</u>	<u>NO GO</u>
1. Recited rules of engagement and rules of interaction.	—	—
2. Performed surveillance using visual search techniques.	—	—
3. Reported status to the evaluator.	—	—
4. Delivered a report using the mnemonic S-A-L-U-T-E (Size, Activity, Location, Uniform, Time, Equipment) to the evaluator.	—	—
5. Prevented unauthorized personnel from entering the perimeter.	—	—
6. Prevented unauthorized personnel from exiting the perimeter.	—	—
7. Detected breaks in the perimeter, signs of tunneling or other possible breaches.	—	—
8. Maintained noise, light, and litter discipline at all times.	—	—

Evaluation Guidance: Score the soldier GO if all steps are performed correctly. Score the soldier NO-GO if any step is performed incorrectly. If the soldier fails any step, explain the error to correct performance.

References

Required
STP 21-1-SMCT

Related
FM 19-4

Comment [DK38]: delete

Decontaminate Equipment Using ABC-M11 Decontamination Apparatus 031-507-1002

Conditions: Given an area of chemical contamination on a vehicle or equipment. Your supervisor directs you to decontaminate with an empty ABC-M11 decontaminating apparatus, two spare nitrogen cylinders, and a 1-1/3-quart can of DS2. You are in MOPP4.

Standards: Cover specified contaminated areas by spraying liquid from the ABC-M11. Standards are not degraded due to performance in MOPP4.

Performance Steps

1. Fill the M11 apparatus.

WARNING: Wear rubber gloves to protect the hands when handling DS2. (For training purposes, use 0.5 ounce of corrosion inhibitor and water.)

- a. Unscrew the spray head from the container.
 - b. Pour the contents of a 1-1/3-quart can of DS2 into the container through the opening in the top of the apparatus. If filling from a large container, pour in DS2 to the level of the yellow line marked "Fill Line." (The end of the container neck inside the container body should be used as a fill guide since it is at the same level as the yellow fill line.)
 - c. Ensure the container's preformed packing (rubber washer) is in place on the spray head and that it is in good condition. Screw the spray head firmly into the opening in the container.
2. Pressurize the M11 apparatus.
 - a. Withdraw the captive safety pin (Figure 1); this will break the safety seal.
 - b. Rest the container on a solid surface and slowly raise the handle, while holding the cylinder steady in place, until the locking pin springs out and locks the handle in place (Figure 2). When the handle is raised, the nitrogen-filled container is punctured and the container pressurized.

WARNING: Do not use DS2 to decontaminate personnel. It irritates the skin and eyes. If DS2 does get on your skin, blot it off and rinse with water.

3. Decontaminate equipment.
 - a. Spray DS2 by depressing the thumb lever (Figure 3).
 - b. Spray parts of vehicles that are most likely to be touched or used, such as door handles, steering wheels, controls, seats, dashboards, levers, gasoline caps, and tools. Hold the apparatus upright so that as much liquid as possible is forced from the container. Remember, the contents of one full container can be discharged in about 30 seconds of continuous spraying time.
 - c. After the first nitrogen-filled cylinder is expended, shake the container to determine if it is empty. Use a second nitrogen-filled cylinder to expel remaining contents.

WARNING: Place handle in lowered position before installing the nitrogen-filled cylinder to prevent premature puncturing of the cylinder and expulsion of nitrogen out of the spray.

- d. To use the spare nitrogen-filled cylinder, depress the handle-locking pin and lower the handle. Raise the thumb lever and push the expended cylinder out of the spray head body. Discard the expended cylinder. Insert the spare nitrogen-filled cylinder into the spray head body, neck down. Release the thumb lever and repressurize the apparatus, repeating step 2b.
- e. When the charge is expended, depress the handle-locking pin and lower the handle. If you have completed spraying, reinstall the captive safety pin and replace the apparatus in the mounting bracket. If not, repeat steps 1 through 3 until you have completed operator's spraydown of the vehicle or equipment.
- f. Whenever possible, those items sprayed with DS2 should be rinsed with water. Rinsing should not be done until at least 30 minutes after spraying.

Evaluation Preparation: Setup: DS2 is not used for training. Use 0.5 ounce of corrosion inhibitor (NSN 6850-00-865-2916) and water. Refer to TM 3-4230-204-12&P, paragraph 2-7, before you set up for your evaluation. For test purposes the soldier must be in MOPP4 and have a vehicle or piece of equipment with a specified area to be decontaminated with the ABC-M11.

Performance Measures

	<u>GO</u>	<u>NO GO</u>
1. Fills M11 decontaminating apparatus.	—	—
2. Pressurizes M11 decontaminating apparatus.	—	—
3. Decontaminates equipment.	—	—
4. Observes all safety precautions.	—	—

Evaluation Guidance: Score the soldier GO if all steps are passed (P). Score the soldier NO-GO if any step is failed (F). If any step is failed, show the soldier what was done wrong and how to do it correctly.

References

Required	Related
TM 3-4230-204-12&P	

**Operate Night Vision Goggles AN/PVS-7
071-710-0008**

Conditions: At night, given night vision goggles AN/PVS-7 with components, accessories, and batteries.

Standards: Inspect night vision goggles AN/PVS-7B for best operational capability. Correctly shut down goggles. Properly stow goggles and all accessories in carrying case. Comply with all warnings and cautions associated with the goggles.

Performance Steps

WARNING: To avoid personal injury or damage to the AN/PVS-7B goggles, consider the following limitations and safety precautions while using the goggles:

1. The goggles require some moonlight, starlight, or both to operate.
2. The amount of available light determines the goggles' level of performance.
3. Operating in shadow from buildings or trees reduces nightlight.
4. The goggles are less effective for viewing into shadowed and other darkened areas than in lighter areas.
5. The goggles are less effective when viewing through rain, fog, sleet, snow, or smoke.
6. When using goggles from a moving vehicle in the fog, rain, sleet, snow, or smoke, vehicle speed must be reduced to avoid over-driving the range of view.
7. Between the last and first quarters of the moon, during operations requiring the use of a protective mask, or both, the assistance driver should use a night-vision device.

1. Prepare the goggles for operation.
 - a. Inventory the carrying case and content to ensure the following accessories are present.
 - (1) Headmount assembly.
 - (2) Demist shields.
 - (3) Brow pads (medium and thick, thin pads is attached to headmount assembly).
 - (4) Operator's manual.
 - (5) Lens paper.
 - (6) Carrying case strap.
 - (7) Light interference filter (LIF).
 - (8) Sacrificial window.
 - (9) Batteries: (2 BA-3058/U or 1 BA-5567/U)
 - (10) Goggles assembly.
 - b. Inspect the goggles.
 - (1) Ensure that the goggles assembly rotary switch is in the OFF position. Inspect goggles assembly and components for damage to optical surfaces, body, eyecups, OFF-ON_PULL/IRR switch and battery cap.
 - (2) Ensure all optical surfaces are clean. Clean with clean water and lens tissue if needed.
 - c. Install batteries.
 - (1) Check and ensure that the OFF-ON-PULL/IR switch is in the OFF position before installing batteries.
 - (2) Comply with all warnings and danger statements that apply to handling batteries.

WARNING: Batteries (alkaline, lithium and mercury) present a potential hazard. Do not heat, puncture, disassemble, short-circuit, try to recharge or otherwise tamper with the batteries. If the battery compartment becomes unusually hot, turn off the equipment. Allow the batteries to cool before you remove them. Batteries have safety vents to prevent explosion. When they vent, you will notice an irritating odor or hear the sound of gas escaping. After batteries vent, they are fairly safe, but you must still handle them with care.

DANGER: IF YOU INHALE SULPHUR DIOXIDE, SEEK MEDICAL ATTENTION.

- (3) Remove the battery cap. Insert two AA batteries (BA-3058/U) or one lithium battery (BA-5567/U) in the battery compartment, positive end (+) first.
- (4) Replace the battery cap.. Tighten it firmly to ensure a watertight seal.
- d. Perform an operational check.
 - (1) Position the OFF-ON-PULL/IR switch to ON. Observe the a green glow gradually appears in each eyepiece.
 - (2) Pull the OFF-ON-PULL/IR switch knob and rotate it clockwise to the IR position. Observe that red light appears in the left eyepiece. This indicates that the IR source is operating. The IR source is located on the left front of the goggles. Do not block it while operating the goggles.
 - (3) Turn off the OFF-ON-PULL/IR switch counterclockwise to the OFF position. Observe that the red light and green glow disappear.
2. Operate goggles.
 - a. Focusing the goggles. If you normally wear eyeglasses, remove them to operate these goggles. You can focus the goggles, so you will not need your eyeglasses.
 - (1) Focus on the image intensifier screen using the diopter adjustment rings.
 - (2) Focus on objects at varying distances using the objective focus adjustment.
 - b. Handheld operation.
 - (1) Position the goggles so that the eyecups seal around your eyes to prevent the green glow from escaping.
 - (2) Position the OFF-ON-PULL/IR switch to ON.
 - (3) Adjust the interpupillary distance by sliding the eyepieces either together or apart so both eyes can observe the entire field of view at the same time.
 - (4) To set the diopter adjustment rings, close your left eye and adjust the right diopter ring for the clearest focus on the image intensifier screen. Close your right eye and adjust the left diopter ring for the clearest focus on the image intensifier screen.
 - (5) Adjust objective lens focus while observing a distant object (at least 4 meters distance) until the sharpest view is obtained.
 - c. Head mount operation.
 - (1) Adjust the headmount assembly.
 - (a) Loosen the four chin straps on the headmount assembly until the end of each strap is about 2 inches from the sliding bar buckles.

NOTE: When installing a headmount assembly over a protective mask, make sure you do not break the seal of the protective mask around your face.

- (b) Grasp the neck pad assembly with both hands. Pull it over your head and down to the back of your neck. If the head mount is too loose, replace the thin pad with the medium or thick pad. The pads are held in place by hook-pile tape.
- (c) Fasten the front and rear snaps in place with your left hand. Hold the chin cup in position on your chin. Adjust both rear chin assembly straps until you feel light pressure against your chin. Do not tighten the strap any farther.
- (d) Continue to hold the chin cup in position. At the same time, remove slack from the front and rear chin straps. Once you have done so - stop. Do not tighten them any farther.

- (e) Make sure the cross-strap assembly does not twist. To remove slack from it, adjust the vertical adjustment strap at the neck pad.
 - (f) Adjust the chin straps and the vertical adjustment strap until both chin cup and the headband assembly are in a comfortable but firm position.
 - (g) Depress the socket release button. Position the headmount socket all the way forward.
- (2) Install the goggles on the headmount assembly.
- (a) Align the goggles latch with the headmount socket. Press and hold the goggles latch lever while you place the goggles into the headmount socket. Release the latch when the goggles fully engage the socket.
 - (b) Depress the socket release button. Move the goggles back toward your eyes until the eyecups and eyepieces are comfortably aligned. The eyecups must seal around your eyes and prevent the green glow from escaping.
- (3) Adjust goggles for operation.
- (a) Position OFF-ON-PULL/IR switch to ON.
 - (b) Adjust the interpupillary distance. Slide the eyepieces together or apart so you can observe the entire field of view with both eyes at the same time.
 - (c) Set the diopter adjustment rings. Close your left eye and adjusting the right diopter ring for the clearest focus on the image intensifier screen. Close your right eye and adjust the left diopter ring for the clearest focus on the image intensifier screen.
 - (d) Adjust the eye relief distance. Press the socket release button. Move the goggles backward and forward to obtain a full field of view of the image intensifier. If necessary, readjust the diopter rings to obtain the best image.
 - (e) Adjust the objective lens focus while observing a distant object (at least 4 meters away) until you obtain the sharpest possible view.
 - (f) Readjust the vertical strap assembly until the goggles align with your eyes.
 - (g) If necessary, adjust the kevlar or M1 headband inside the helmet for a proper fit over the headmount assembly.
3. Operate goggles under unusual conditions.
- a. Extreme darkness.
 - (1) Pull the OFF-ON-PULL/IR switch out and rotate it clockwise to the IR position.
 - (2) Ensure the eyecups are positioned to prevent light escaping from the goggles.

WARNING: The infrared source is a light that is invisible to the unaided eye for use during conditions of extreme darkness. The enemy can detect it with night vision devices. The infrared source is used to see objects within a distance of 3 meters.

- b. Dust and sand. Attach the sacrificial window to protect the objective lens from scratches and other damage.
 - (1) Remove the sacrificial window from the carrying case.
 - (2) Carefully push the sacrificial window over the objective lens until it pops.
 - (3) Turn the sacrificial window clockwise until it snaps in place.
 - (4) Remove the sacrificial window by reversing the installation procedures.
- c. Rainy and humid conditions. Press each eyecup over the diopter ring. Rotate it into correct viewing position.
 - (1) Remove the eyecups by carefully pulling them off the diopter ring.
 - (2) Carefully press a demist shield onto each eyepiece. Do not smudge the eyepiece or demist shields.
 - (3) Replace eyecups. Press each eyecup over the diopter ring. Rotate it into correct viewing position.
- d. Laser threat environment. Install the light interference filter (LIF). Using this filter will slightly reduce system gain.
 - (1) Remove the container/wrench from the carrying case.
 - (2) Remove the lens cap or sacrificial window from the objective lens of the goggles.
 - (3) Open the container/wrench and remove the LIF.

- (4) Hold the LIF by the notched end. Thread it clockwise into the end of the objective lens.
- (5) Use the ridged side of the container/wrench as a wrench. Engage the ridges on the container with the ridges on the LIF. Hand tighten the LIF.
- (6) Place the empty container/wrench back into the pouch in the carrying case.

NOTE: The lens cap and the sacrificial window will fit onto the end of the objective lens with the LIF in place. However, the lens cap and sacrificial window will not snap into place without the LIF attached.

- (7) Replace the lens cap or the sacrificial window onto the end of the objective lens and over the LIF.
 - (8) Remove the LIF by reversing the installation procedures.
- e. NBC environment.
- (1) Place the protective mask on your head per instructions provided with the protective mask.
 - (2) Make sure you do not break the seal of the protective mask around your face when you install the headmount assembly over the protective mask.
4. Install and operate the snap-on compass.
 - a. Remove the objective lens cover from the goggles. Secure the snap-on compass to the lens with the round part of the activation button facing down.
 - b. Turn the goggles on. Push up on the activation button to determine azimuth direction.
 5. Attach the 3X magnifier telescope assembly.
 - a. Objective focus cover attached. Push the objective focus cover sleeve onto the goggles' objective focus ring.
 - b. Objective focus cover not attached to goggles. Screw the 3X magnifier directly into the goggles' objective focus ring.
 6. Stow the night vision goggles.
 - a. Shut down the goggles. Move the OFF-ON-PULL/IR switch to OFF.
 - b. Remove the goggles from the head mount (if attached). Depress the latch lever and remove the goggles.
 - c. Unscrew the battery cap, remove the battery, and replace the battery cap.
 - d. Remove the demist shields and sacrificial window, if installed.
 - e. Install the lens cap.
 - f. Ensure the goggles are free of dirt, dust, and moisture.
 - g. Place the demist shields and the battery into their proper carrying case pockets.

CAUTION: To prevent damage to window, place the sacrificial window at bottom left or right corner of the carrying case accessory pocket.

- h. Place the lens paper, sacrificial window, and operator's manual in the accessory pocket located under the shallow pocket that contains the goggles.
- i. Place the goggles (objective lens down) into the shallow pocket of the carrying case.
- j. Remove the headmount assembly. Unsnap the front and rear straps. Lift the headmount assembly up and off your head. Stow the assembly in the deep pocket of the carrying case. Close the carrying case.

Evaluation Preparation:

Setup: Evaluate this task in a classroom where light can be controlled to simulate nighttime. Provide the soldier with a set of night vision goggles AN/PVS-7B, components, and batteries, as described in the task conditions statement. Have the soldier prepare the goggles for operation, operate the goggles using the headmount assembly, shut down the goggles, and stow the goggles. Evaluate the soldier's ability to select and attach the appropriate components by telling him to prepare the goggles for operation in the following conditions: dust and sand, rain or high humidity, or laser threat environment. If snap-on compass and 3X magnifier are available, evaluate the soldier's ability to attach them to the goggles.

Brief Soldier: Tell the soldier that he is to prepare the goggles for operation, operate the goggles using the headmount assembly, shut down and stow the goggles, and attach components to operate the goggles in various conditions as instructed. Tell him that he must notify you before turning the goggles ON and after turning them OFF, so you can darken or lighten the room. Tell the soldier not to energize the goggles when the room lights are on.

Performance Measures	<u>GO</u>	<u>NO GO</u>
1. Prepare goggles for operation.	—	—
a. Inventory carrying case content to ensure all accessories are present.		
b. Inspect the goggles assembly and components for serviceability.		
c. Install batteries correctly.		
d. Perform an operational check.		
2. Operate goggles in hand-held mode.	—	—
3. Operate goggles with head mount.	—	—
a. Adjust the headmount assembly for proper fit.		
b. Install goggles correctly on the headmount assembly.		
c. Adjust goggles for operation/		
4. Operate goggles during unusual conditions.	—	—
a. Extreme darkness. Operate goggles using IR source.		
b. Dust and sand. Attach the sacrificial window.		
c. Rainy and humid conditions. Install demist shields to minimize diopter fog.		
d. Laser threat environment. Install the light interference filter (LIF).		
e. NBC environment.		
(1) Place the protective mask on your head IAW instructions provided with the protective mask.		
(2) Do not break the seal of the protective mask around your face when you install the headmount assembly over the protective mask.		
5. Install and operate snap-on compass (if available).	—	—
6. Attach 3X magnifier telescope assembly (if available).	—	—
7. Stow the night vision goggles.	—	—

Evaluation Guidance: If the soldier passes all steps, score him GO. If he fails any steps, score him NO-GO, then show him what he did wrong and how to do it correctly.

Maintain Night Vision Goggles AN/PVS-7
071-710-0009

Conditions: Given night vision goggles AN/PVS-7B with components, accessories, batteries, clean water, clean lint-free cloths, and a requirement to perform required operator maintenance on the goggles.

Standards: Clean and inspect night vision goggles, components, and accessories for serviceability; report unserviceable items to the supervisor. Properly stow the goggles and accessories. Comply with all warnings and cautions associated with these goggles.

Performance Steps

1. Inventory the carrying case for the following items.

CAUTION: To prevent damage to your equipment, use only lens tissue or clean cloth when cleaning lenses.

- a. Headmount assembly
 - b. Demist shields.
 - c. Brow pads-medium and thick (the thin pad is attached to the headmount assembly).
 - d. Operator's manual.
 - e. Lens paper.
 - f. Carrying case strap
 - g. Light interference filter (LIF).
 - h. Sacrificial window.
 - i. Batteries: (2 BA-3058/U or 1 BA-5567/U).
 - j. Goggles assembly.
2. Clean an AN/PVS-7B
 - a. Clean all optical surfaces with lens paper dampened with clean water (water temperature should be between 70 and 80 degrees Fahrenheit) and wipe clean.
 - b. Use a clean lint-free cloth, dampened with clean water, to remove all dirt and grease from all exterior surfaces.

CAUTION: Handle all components with extreme care. Protect against dirt, dust, fingerprints and excessive moisture.

3. Inspect the accessories and goggles for conditions indicated. Take corrective action as indicated for damaged items.
 - a. Goggles assembly.
 - (1) Inspect all surfaces for dirt, fingerprints, residue, chips or cracks. If necessary, use clean water and lens tissue to wash and dry the lens. If you observe chips or cracks in a lens, refer to your supervisor for higher level maintenance.
 - (2) Inspect goggles housing for damage. If you observe chips or cracks in a lens, refer to your supervisor for higher level maintenance.
 - (3) Inspect the battery compartment for corrosion, defective battery cap, spring contact and performed packing in the cap. If you find corrosion or if the battery spring is defective, refer to your supervisor for higher level maintenance.
 - (4) Check the diopter adjustment rings to make sure the eyepieces move freely. If they do not, refer to your supervisor for higher level maintenance.
 - (5) Check the interpupillary adjustment on the eyepiece to see if it moves freely. If it does not, refer to your supervisor for higher level maintenance.

- (6) Turn the objective lens focus knob to make sure it moves freely. The knob should turn about 1/3 turn or 120 degrees. If the knob does not move freely, refer to your supervisor for higher level maintenance.
 - (7) Inspect for bent, broken, dried, cracked, torn, dusty, dirty or improperly fitting eye cups. If necessary, clean and dry the eye cups with clean water and a lens tissue. If the eye cups are defective, refer to your supervisor for higher level maintenance.
 - (8) Check the OFF-ON-PULL/IR switch. Move the switch from OFF to ON and to PULL/IR. Each position should have a definite stopping point. If the knob is broken, refer to your supervisor for higher level maintenance.
 - (9) Inspect the headmount assembly.
 - (a) Inspect the headmount strap assemblies and brow pads for holes, cracks, defective fasteners or contamination. Remove and replace the brow pad by pulling it out (hook-pile tape holds the brow pads in place). Press in a new pad.
 - (b) Inspect the headmount assembly eye relief. Press the socket release button and check the socket assembly to see if it moves freely. Inspect for dirt and damage. Clean it if needed. If it does not move freely or if you observe damage, refer to your supervisor for higher level maintenance.
 - (c) Inspect the headmount socket and the goggles latch. Inspect and clean the headmount socket. Check to see if the socket and latch work correctly by inserting the goggles latch into the socket. Verify that they link securely. If the socket assembly does not work properly or if you observe damage, refer to your supervisor for higher level maintenance.
 - (10) Inspect the demist shields for dirt, dust, scratches or damage. Clean the shields only with dry lens tissue.
 - (11) Inspect the sacrificial window for dirt, dust, scratches or damage. If necessary wash it with clean water and dry it with a lens tissue. If you observe damage, refer to your supervisor for higher level maintenance.
 - (12) Inspect the neck cord for damaged and frayed ends. Re-tie if necessary. If you observe damage, refer to your supervisor for higher level maintenance.
 - (13) Inspect the carrying case. Remove all accessories and shake out all loose dirt or foreign matter. Wipe the interior and exterior with a clean, dry lint-free cloth. If necessary, use a mild detergent to remove dirt and grease.
 - (14) Inspect the 3X magnifier. Inspect all lenses for dirt, fingerprints, residue, chips or cracks. If necessary, clean and dry the lens with clean water and a lens tissue. Inspect the housing for damage. If you observe any chips or cracks in the housing, refer to your supervisor for higher level maintenance.
 - (15) Inspect the snap-on compass for dirt and damage. If necessary, clean it with clean water and a cloth. If you observe damage, refer to your supervisor for higher level maintenance.
4. Perform an operational check.
- a. Install batteries.
 - (1) Check and make certain that the OFF-ON-PULL/IR switch is in the OFF position.
 - (2) Comply with all cautions, warning, and danger statements.
 - (3) Remove the battery cap. Insert two AA batteries (BA-3058/U) or one lithium battery (BA-5567/U) in the battery compartment, with the positive end (+) first.
 - (4) Replace the battery cap. Tighten it firmly to ensure a watertight seal (Figure 4).

WARNING: Alkaline, lithium, and mercury batteries are potential hazards. Do not heat, puncture, disassemble, short-circuit, try to recharge, or otherwise tamper with the batteries. If the battery compartment becomes unusually hot, turn off the equipment. Try to wait until the batteries cool before you remove them. Batteries have safety vents to prevent explosion. When they vent, you will notice an irritating odor or hear the sound of gas escaping. After batteries vent, they are fairly safe, but you must still handle them with care.

DANGER: IF YOU INHALE SULPHUR DIOXIDE, SEEK MEDICAL ATTENTION.

- b. Check goggles for proper operation. Perform the following procedures only in darkened conditions. If you must check the goggles during daylight, use the lens cap to cover the objective lens:
 - (1) Position the OFF-ON-PULL/IR switch to ON. Note the green glow that gradually appears in each eyepiece.
 - (2) Pull the OFF-ON-PULL/IR knob. Rotate it clockwise to the IR position. Note the red light that appears in the left eyepiece. This light indicates that the IR source is operating. The IR source is located on the left front of the goggles. Do not block the IR source when operating the goggles.
 - (3) Turn the OFF-ON-PULL/IR switch counterclockwise to the OFF position. Note that the red light and green glow disappear.
 - (4) Shut down the goggles by positioning the OFF-ON-PULL./IR switch to OFF.
- 5. Stow the night vision goggles.
 - a. Unscrew the battery cap, remove battery, and replace the battery cap.
 - b. Place demist shields and battery into their proper carrying case Pocket.

CAUTION: Place the sacrificial window at the bottom left or right corner of the carrying case accessory pocket of the carrying case. Close the carrying case.

- c. Place the lens paper, sacrificial window, and operator's manual in the accessory pocket located under the shallow pocket that contains the goggles.
- d. Place the goggles (objective lens down) into shallow pocket of carrying case.
- e. Stow the headmount assembly in the deep pocket of the carrying case. Close the carrying case.

Evaluation Preparation:

Setup: Provide the soldier with equipment and materials listed in conditions.

Brief Soldier: Tell soldier that he/she is to inspect the components, accessories, and goggles for completeness and serviceability, and to clean them as required. Then he/she is to perform an operational check, shut down the goggles, and stow them and their accessories.

Performance Measures

	<u>GO</u>	<u>NO GO</u>
1. Inventory carrying case for correct content.	—	—
2. Clean the AN/PVS-7B and accessories using correct cleaning techniques.	—	—
3. Inspect accessories and goggles for serviceability.	—	—
4. Perform an operational check.	—	—
5. Stow the night vision goggles.	—	—
6. Comply with safety precautions and warnings.	—	—

Evaluation Guidance: If the soldier passes all steps, score him GO. If he fails any steps, score him NO-GO, then show him what he did wrong and how to do it correctly.

Prepare SINGARS (Manpack) For Operation
113-587-1064

Conditions: Given an operational SINGARS manpack, radio with battery box CY-8346, battery BA-5590, antenna AS-3683, handset H-250, pack frame with straps, TM 11-5820-890-10-1, and TM 11-5820-890-10-3.

Standards: The standards are met when battery is correctly installed, function controls are correctly preset for operation, radio is mounted on backpack, and accessories are correctly connected.

Evaluation Preparation:

Performance Measures

	<u>GO</u>	<u>NO GO</u>
1. Install batteries.	___	___
2. Install antenna.	___	___
3. Connect handset H-250.	___	___
4. Assemble radio and pack frame.	___	___
5. Preset function controls.	___	___

Evaluation Guidance: Score the soldier GO if all steps are passed. Score the soldier NO-GO if any step is failed. If the soldier fails any step, show what was done wrong and how to do it correctly. Have the soldier practice until he can correctly perform the task.

Install A Hot Loop
113-588-1087

Conditions: Given WD-1/TT or WD-1A on reel, three operational two-wire tactical field telephones, tool equipment TE-33, reel unit RL-31E, wire tags, stakes, hammer, and unit signal operation instruction (SOI).

Standards: Standard is met when a three-station hot loop is installed and a communications check is made.

Performance Steps

1. Install a field wire loop.
 - a. Lay out the field wire from position A to each position in turn, until all positions are connected; complete loop by returning to position A (Figure 1).
 - b. Keep wire behind the individual positions.
 - c. Tie the wire to a fixed object, or stake, near each position and leave enough slack in the wire for connections.
2. Connect each two-wire tactical telephone to the hot loop, position A.
 - a. Connect the hot loop to telephone.
 - (1) Strip 1/2 inch of insulation off the two wires at each end of the hot loop.
 - (2) Connect one of the wires from each end of the hot loop to one binding post of this telephone, and the other wire from each end of the loop to the other binding post (Figure 2).
 - b. Connect the other telephones to the hot loop.
 - (1) Go to one of the positions in the hot loop.
 - (2) Pick up the wire.
 - (3) Cut the insulation on one conductor without cutting the wire strands. Use the TL-13-A pliers or TL-29 knife.
 - (4) Grasp the insulation on each side of the cut and pull the insulation apart to expose 1/2 inch of wire strands on each conductor (Figure 3).
 - (5) Repeat steps in subparagraphs (1) and (2) on the other conductor.
 - (6) Slide an exposed 1/2-inch section of one conductor into one binding post of the telephone.
 - (8) Repeat steps in subparagraphs (1) through (7) to connect each telephone in the hot loop.
3. Make a communications check. Use any telephone in the system and ring down the circuit. If all positions answer, the hot loop is installed correctly. If any position does not answer, check the connections.

Evaluation Preparation:

Performance Measures

GO NO GO
____ ____

1. Install a field wire hot loop.
 - a. Lay out the field wire from position A to each position in turn, until all positions are connected, then complete the loop by returning to position A.
 - b. Keep the wire behind the individual positions.
 - c. Tie the wire to a fixed object or stake near each position, and leave enough slack in the wire for connections.

2. Connect each two-wire tactical telephone to the hot loop at position A. — —
 - a. Connect the hot loop to the telephone.
 - b. Strip 1/2 inch of insulation off the two wires at each end of the hot loop.
 - c. Connect one of the wires from each end of the hot loop to one binding post of this telephone and the other wire from each end of the loop to the other binding post.
3. Connect the other telephones to the hot loop. — —
 - a. Go to one of the positions in the hot loop.
 - b. Pick up the wire.
 - c. Cut the insulation on one conductor without cutting the wire strands.
 - d. Strip 1/2 inch of insulation off the two conductors.
 - e. Connect conductors to telephones.
4. Perform a communications check. — —

Evaluation Guidance: Score the soldier GO if all steps are passed. Score the soldier NO-GO if any step is failed. If the soldier scores NO-GO, show him what was done wrong and how to do it

References

Required

Related

TM 11-5805-201-12

Install Telephone Set TA-312/PT 113-600-1012

Conditions: This task can be performed in an NBC environment. You will be given a telephone set TA-312/PT, two BA-30 batteries, tool equipment TE-33, telephone cable WD-1(*)/TT (installed), tags, grease pencil, TC 24-10 and TM 11-5805-201-12.

Standards: The telephone set TA-312/PT must be prepared for type of service, positioned for operation, batteries installed, connected to field wire, and buzzer volume adjusted.

Performance Steps

1. Install the TA-312/PT on a desk, pole, or tree.
2. Set selector switch for proper service.
3. Connect telephone cable to the TA-312/PT.
4. Install power source.
5. Connect external headset when required.
6. Install/remove deicing screen when required.
7. Establish communications.

Evaluation Preparation:

Performance Measures

(Refer to TM 11-5805-201-12 for PMs 1 through 7.)

GO NO GO

- | | | |
|--|-------|-------|
| 1. Install the TA-312/PT on a desk, pole, or tree. | _____ | _____ |
| 2. Set selector switch for proper service. | _____ | _____ |
| 3. Connect telephone cable to the TA-312/PT. | _____ | _____ |
| 4. Install power source. | _____ | _____ |
| a. Connect external batteries when required. | | |
| b. Install batteries in telephone set. | | |

NOTE: PMs 4a and 5 may be used if the telephone operator must have his hand free during operation.

- | | | |
|---|-------|-------|
| 5. Adjust the buzzer volume, when required. | _____ | _____ |
| 6. Connect external headset, when required. | _____ | _____ |

NOTE: Deicing the screen may be used to prevent transmitter from icing during extreme cold weather.

NOTE: Performance measures 6 and 7 may be used if the telephone operator's hands must be free during operation.

- | | | |
|---|-------|-------|
| 7. Install/remove deicing screen when required. | _____ | _____ |
| 8. Install external batteries. | _____ | _____ |
| 9. Establish communications. | _____ | _____ |

Evaluation Guidance: Score the soldier GO if all steps are passed. Score the soldier NO-GO if any step is failed. If the soldier scores NO-GO, show him what was done wrong and how to do it correctly.

References

Required

- TC 24-20
- TM 11-5805-201-12

Related

**Operate Telephone Set TA-312/PT
113-600-2007**

Conditions: This task is performed in a tactical or non-tactical situation, under all weather conditions, and it may be performed in an NBC environment. You will be provided with the following: 1. Telephone set TA-312/PT (installed), two each. 2. Headset H-144/U. 3. Screwdriver. 4. TM 11-5805-201-12.

Standards: Task standard has been met when a call has been initiated and completed IAW the performance measures.

Evaluation Preparation:

Performance Measures	<u>GO</u>	<u>NO GO</u>
NOTE: Refer to TM 11-5805-201-12 for performance measures.		
1. Initiate a call in the prescribed mode of operation (paragraph 3-2).	_____	_____
2. Answer calls in the prescribed mode of operation (paragraph 3-3a).	_____	_____
NOTE: Performance measure 3 may be used if the telephone operator must have his hands free during operation.		
3. Answer calls using external headset (paragraph 3-3b).	_____	_____
NOTE: Operation under conditions less than ideal may require the operator to make special operating considerations.		
4. Operate telephone set under unusual conditions (paragraph 3-4).	_____	_____

Evaluation Guidance: Score the soldier GO if all steps are passed (P). Score the soldier NO-GO if any step is failed (F). If any step is failed, show the soldier what was done wrong and how to do it correctly.

References

Required

TM 11-5805-201-12

Related

**Perform Operator PMCS On Telephone Set TA-312/PT
113-600-3015**

Conditions: Given a requirement and a telephone set TA-312/PT, two BA-30 or BA-3030 batteries, telephone set TA-838/TT, four BA-42 or BA-3042 batteries, telephone set TA-1/PT, lint-free cloth and brush, DA Form 2404 (Equipment Inspection and Maintenance Worksheet), denatured alcohol, TM 11-5805-201-12, TM 11-5805-650-12, TM 11-5805-243-13, and DA Pam 738-750.

Standards: Task standard has been met when the maintenance has been performed and DA Form 2404 is completed.

Evaluation Preparation:

Performance Measures	<u>GO</u>	<u>NO GO</u>
1. Perform maintenance on TA-312/PT. (Refer to TM 11-5805-201-12.)	—	—
2. Complete DA Form 2404.	—	—
3. Perform maintenance on TA-838/TT. (Refer to TM 11-5805-650-12.)	—	—
4. Complete DA Form 2404.	—	—
5. Perform maintenance on TA-1/PT. (Refer to TM 11-5805-243-13.)	—	—
6. Complete DA Form 2404.	—	—

Evaluation Guidance: Score the soldier GO if all steps are passed. Score the soldier NO-GO if any step is failed. If the soldier scores NO-GO, show him what was done wrong and how to do it correctly.

References

Required

DA Form 2404
TM 11-5805-201-12
TM 11-5805-243-13

Related

DA Pam 738-750

Skill Level 2

Subject Area 2: Administrative Tasks

Perform Music Librarian Functions**514-464-2191**

Conditions: Given a requirement to manage the music library and all the necessary accessories required to perform music librarian functions.

Standards: Completed all necessary steps to perform music librarian functions.

Performance Steps

1. Process music.
 - a. Process new music.
 - (1) Catalog music by category, preferably through an automated system that allows searching by style, composer, title, etc.
 - (2) Place unit identification stamp and catalog number on music.
 - (3) File and store music in score order.
 - b. Process old and collected music.
 - (1) File and store music in score order.
 - (2) Replace missing parts.
2. Maintain updated music lists.
3. Request new music using various sources from supply.
4. Complete music requests as required by commander or NCOIC.
5. Maintain accountability of all music library materials (e.g. music, flip folders, pouches, method books, reference books, CD's, tapes, records, video cassettes).
6. Maintain music for folders and pouches for all performing ensembles.
7. Perform coordination steps prior to rehearsals or commitments:
 - a. Check with the Operations section to make sure any special music requests can be accommodated.
 - b. Check with the Commander before rehearsals so any new music can be passed out prior to rehearsal or commitment.
 - c. Ensure stand lights, extension cords, and conductor stand are available and in place for rehearsals or commitments.

Evaluation Preparation:

Set Up: Ensure that all materials required in the Conditions statement are available to the soldier.
 Evaluate this task during individual or collective training.

Brief the soldier: "You must complete all the performance steps to perform music librarian functions without error."

Performance Measures

GO NO GO

- | | | |
|---|-------|-------|
| 1. Processed new, old and collected music. | _____ | _____ |
| 2. Maintained updated music lists. | _____ | _____ |
| 3. Requested new music. | _____ | _____ |
| 4. Completed music requests as required by commander or NCOIC. | _____ | _____ |
| 5. Maintained accountability of all music library materials. | _____ | _____ |
| 6. Maintained music for folders and pouches for all performing ensembles. | _____ | _____ |
| 7. Performed coordination steps prior to rehearsals or commitments. | _____ | _____ |

Evaluation Guidance: Score the soldier GO if all steps are performed correctly. Score the soldier NO-GO if any step is performed incorrectly. If the soldier fails any step, explain the error to correct performance.

**Prepare And Process Personal Clothing Request
 101-521-1102**

Conditions: You are the unit supply clerk. The supply sergeant tells you a soldier needs personal clothing. Materials required: personal clothing request forms, AR 700-84, and CTA 50-900.

Standards: Prepare a personal clothing request without rejection of the request by the central issue point or the Army military clothing sales store.

Evaluation Preparation:

Performance Measures

GO NO GO

NOTE: Refer to CTA 50-900 and AR 700-84 for Performance Measure 1. Refer to AR 700-84 for Performance Measures 2 and 3.

- | | | |
|---|-------|-------|
| 1. Prepares a personal clothing request. | _____ | _____ |
| a. Initial and supplemental clothing allowances authorized for enlisted personnel are listed in CTA 50-900. This CTA also includes the safety and protective clothing and equipment for the protection of personnel in accordance with AR 385-32. | | |
| b. Each column in the CTA is applicable only to that Army component. Special skill identifier and MOS designations are applicable only to personnel with the same SSI and MOS in their MTOE, TDA, and JTD. | | |
| c. Items of clothing and equipment identified by standard line item numbers are the latest adopted items of material. | | |
| d. Complete instructions for the preparation of personal clothing requests are located in Chapter 4 and 5, AR 700-84. | | |

- 2. Ensures that the unit commander or authorized representative signs the request. ___ ___
- 3. Files the completed document. ___ ___
 - a. The unit copy will be placed within the soldier issue files and after 6 months of active duty are completed, an inventory and inspection of the individuals clothing and footwear will be accomplished. If all entitlements are on hand and in serviceable condition, the unit's copy of the DA Form 3078 will be destroyed.

Evaluation Guidance: Score the soldier GO if all steps are passed (P). Score the soldier NO-GO if any step is failed (F). If the soldier fails any step, show what was done wrong and how to do it correctly.

References

Required
AR 700-84

Related

**Prepare And Maintain Organization Clothing And Individual Equipment Record
101-521-1103**

Conditions: You are a unit supply clerk working at a central issue facility (CIF), and new personnel have arrived. Materials required: organization clothing and equipment records, DA Pam 710-2-1, and CTA 50-900.

Standards: Perform all steps in sequence to prepare and maintain organization clothing and equipment records.

Evaluation Preparation:

Performance Measures

GO NO GO

NOTE: Refer to DA Pam 710-2-1 and CTA 50-900 for Performance Measures 1 and 2. Refer to DA Pam 710-2-1 for Performance Measures 3 through 5.

- 1. Prepares a clothing and equipment record. DA Pam 710-2-1, Chapter 10. ___ ___
- 2. Records the authorized allowances. ___ ___
 - a. Organizational clothing and individual equipment allowances are listed in CTA 50-900. This CTA also includes the safety and protective clothing and equipment for the protection of personnel in accordance with AR 385-32.
 - b. Each column in the CTA is applicable only to that Army component. SSI/MOS designations are applicable only to personnel with the same SSI/MOS in their MTOE/TDA/JTD.
 - c. Items of clothing and equipment identified by standard line item numbers are the latest adopted items of material.
 - d. Complete instructions for the preparation of personal clothing requests are located in Chapter 4, AR 700-84.
- 3. Records the issue or receipt of clothing and equipment. DA Pam 710-2-1 Chapter 10. ___ ___

- 4. Ensures individual enters signature and date. DA Pam 710-2-1, Figure 10-2. — —
- 5. Prepares the organization clothing and equipment record form as a summary of issue or turn-in. DA Pam 710-2-1, Chapter 10, paragraph 10-7, and Figure 10-4. — —

Evaluation Guidance: Score the soldier GO if all steps are passed (P). Score the soldier NO-GO if any step is failed (F). If the soldier fails any step, show what was done wrong and how to do it correctly.

References

Required

- AR 710-2
- DA Pam 710-2-1

Related

Subject Area 3: Tactical Tasks

Operate The M8A1 Alarm System

031-504-1008

Conditions: Given an M8A1 alarm system, an M273 maintenance kit, BA3517/U and BA3030 batteries, a reel of field wire (WD-1/TT), a wire cutter, TM 3-6665-312-12&P, and a directive to employ the alarm in the fixed emplacement mode. This task can be performed in MOPP4.

Standards: Perform operator-level PMCS and operate the M8A1 alarm system IAW TM 3-6665-312-12&P, without causing damage to the equipment. Standards are not degraded due to performance in MOPP4.

NOTE: Uncorrected deficiencies must be recorded on DA Form 2404 IA W DA Pam 738-750. However, this is not a performance measure of this task.

Performance Steps

NOTE: The cell module of the M43A1 detector contains a radioactive source, Americium-241. Before using the M43A1 detector, ensure the operator has had a radiation safety orientation IAW a Nuclear Regulatory Commission By-Product Materials License (BML 12-00722-13) issued to Department of the Army, US Army Armament, Munitions and Chemical Command, Rock Island, IL. This orientation (two hours) must address the following subjects:

1. Location of radioactive material in equipment.
2. Hazards associated with Americium-241 isotopes.
3. Hazards associated with the equipment; for example, gamma field and problems if ingested.
4. What to do in an emergency situation; for example, fire or destruction.
5. Keeping the NBC specialist or officer informed of problems and questions.
6. The maintenance procedures that may be done only by test measurement diagnostic equipment.
7. Packaging and shipment of equipment.

WARNING: The cell module of the M43A1 detector contains Americium-241, a radioactive source. If broken, the module is potentially dangerous. Do not attempt to remove the cell or pump modules.

8. Follow safety procedures for storage, shipment, and disposal IAW TM 3-6665-312-12&P, local regulations, and AR 385-11.

WARNING: If a cell or pump module is damaged, notify your NBC NCO. The NBC NCO must then notify the NBC officer and the radiation protection officer (RPO).

9. Wrap the M43A1 detector (with its damaged cell or pump module) in a plastic bag and ship in the original packing container, if available, to direct support maintenance for evaluation. If skin contact is made with any area thought to be contaminated, wash immediately with nonabrasive soap and water.

WARNING: Do not operate an M43A1 detector indoors without an outlet filter. Never operate an M43A1 detector inside a moving vehicle.

WARNING: Do not dispose of a used outlet filter except under the supervision of the NBC NCO officer or the local RPO. You must wear disposable gloves.

WARNING: High voltage is used in the operation of this equipment.

10. Death on contact may result if personnel fail to observe safety precautions when performing maintenance procedures on the M43A1 detector.
 - a. u Disconnect power supplies before performing maintenance to prevent death or possible serious injury to personnel.
 - b. u Disconnect the M10 or M10A1 power supply from the AC power outlet before removing the fuses to prevent possible death or serious injury to personnel.
11. Perform operator-level PMCS on the M43A1 detector of the M8A1 alarm system.
 - a. Detector exterior. Look at outside of M43A1 for dirt, corrosion, and broken or missing parts.

NOTE: Clean off dirt with water only. Do not use cleaner, soap, or detergent of any kind.

- b. Rain shield and adapter assembly. Unscrew rain shield from handle. Remove adapter from rain shield and check both for dirt and chips. Check preformed packing on adapter and nonmetallic washer on rain shield for cracks, cuts, or dirt. Check for missing parts. Return rain shield and adapter assembly to handle.
- c. Flowmeter. Unscrew flowmeter from handle. Check for missing parts, dirt, or cracks. Check nonmetallic washer and meter adapter for dirt or cracks. Return flowmeter to handle.
- d. Top case. Release four clamping catches and lift top case from bottom case. Lay top case on its side. Check J10 test connector for dirt or corrosion. Look at detector interior and inspect for broken, loose, or missing parts.
- e. Bottom case. Inspect bottom case for bent, broken, or corroded heater contacts. Inspect rubber seal for cuts or cracks. Set top case into bottom case and clamp four clamping catches.
- f. Operational check.
 - (1) Unscrew thumbscrew from air inlet. Remove rain shield and adapter from handle. Separate rain shield and adapter by pulling apart.
 - (2) Screw adapter into air inlet.
 - (3) Store rain shield in handle.
 - (4) Remove flowmeter from handle.
 - (5) Put flowmeter onto adapter.
 - (6) Attach BA3517/U battery. Tilt detector and insert strike catch on bottom of detector into metal strap on battery. Clamp detector to battery using clamping catch.
 - (7) Remove air outlet cap. Remove cover from 24 VDC input and connect power cable.

NOTE: If alarm sounds when battery is connected, allow the alarm to sound at least five times. Then press battery test and reset press button. This procedure may have to be repeated several times.

- (8) Press and hold battery test and reset press button. Read detector meter. Detector meter should read in black band. Release battery test and reset press button.
- (9) Flowmeter ball should read within green band of flowmeter.
- (10) Look at detector meter on top case. Meter should be in green band.

NOTE: If detector has not been in use for a long time, it may take 15 minutes for meter to reach green band.

- (11) Release side and rear clamping catches and detector will open just far enough to break air seal between top case and bottom case.
- (12) Observe flowmeter while closing off air outlet with air outlet cap. The flow rate should drop to zero when air outlet is capped. Remove cap from air outlet immediately after ball drops to zero. Attach clamping catches to detector.

NOTE: Do NOT run detector for more than 30 seconds with air outlet cap in place, or damage to equipment may result.

- (13) With voltage meter in green band, press and release bit press button. No flow will show on flowmeter and alarm horn will sound.
- (14) While alarm is sounding, turn horn volume knob to check volume changes from low to high.
- (15) Disconnect power cable from 24 VDC input.
- (16) Remove air filter plug from air filter port.
- (17) Remove air filter and touch to back of hand. It should be warm. Discard if dusty.
- (18) Obtain a test paddle from the M273 maintenance kit. Insert test paddle and install air filter plug. Connect power. Alarm may sound.
- (19) Press and release battery test and reset press button. Within two minutes alarm should sound.

NOTE: If alarm does not sound within two minutes, repeat test once more with a new test paddle. Discard old test paddle.

- (20) Remove air filter plug. Remove test paddle from air filter port. Install serviceable air filter. Reinstall air filter plug. Return test paddle to M273 kit.
- (21) Allow alarm to sound at least five times. Then press and release battery test and reset press button. This procedure may have to be repeated several times. Alarm will not sound, pump will start to pump air again, and detector meter will read in green zone within five to ten minutes.
- (22) Remove flowmeter and store in handle.
- (23) Remove shield from handle and place it on the adapter.
- (24) Disconnect power from 24 VDC input connector.
- (25) Place protective cover on 24 VDC input connector.
- (26) Remove adapter from air inlet and rain shield from handle. Press adapter into rain shield and store in handle.
- (27) Screw thumbscrew into air inlet.
- (28) Put air outlet cap on air outlet.

NOTE: The detector is now ready for assembly and preparation for use.

12. Perform operator-level PMCS on the M42 alarm of the M8A1 alarm system.
 - a. M42 alarm exterior. Look at outside of M42 alarm for dirt, corrosion, and broken or missing parts.
 - b. Horn, light, and battery test.

NOTE: Notify personnel within hearing range that the M42 alarm will be tested.

- (1) Turn selector switch to test. Horn should sound and alarm-red light should flash.
- (2) If M42 alarm does not work, replace batteries as follows: Turn selector switch to horn off. Loosen four knurled screws and separate panel assembly from housing. Release spring-tension clip and open hinge cover of battery retainer. Remove batteries from battery retainer and discard. Obtain four BA3030 batteries. Install batteries in battery retainer; close hinged cover and secure it with spring-tension clip. Position panel assembly in housing. Secure by tightening four knurled screws. Repeat horn, light, and battery test. If retest fails, take unit to unit maintenance.

13. Assemble and prepare the M8A1 alarm for use in the fixed emplacement mode.

- a. M43A1 detector and BA3517/U battery.
 - (1) Insert strike catch on detector unit into slot of metal strap on battery.
 - (2) Engage and lock clamping catch onto catch on opposite side of detector unit.
 - (3) Remove thumbscrew from air inlet.
 - (4) Remove air outlet cap from air outlet.

NOTE: M43A1 is now ready for operation.

- b. M42 alarm.
 - (1) Use Figure 1 as a guide for connecting more than one M42 alarm to a M43A1 detector.
 - (2) Allowing about 1 foot of slack at the end of each cable, string WD-1/TT telephone cable between the detector unit (1) and the M42 alarms (2) shown.
 - (3) About 9 inches from the end of the telephone cable, tie each telephone cable to the D-ring (3) on its alarm.

NOTE: Maximum cable length must not exceed 400 meters from the detector to farthest alarm.

- (4) Strip about 1 inch of insulation from the end of each wire to be connected.
- (5) Connect wires to binding posts.
- (6) About 9 inches from detector end of telephone cable, tie each telephone cable to strap fastener loop on detector.
- (7) Strip about 1 inch of insulation from each wire to connector.
- (8) Connect wires to binding posts.
- (9) Turn selector switch to horn on position.

NOTE: The alarm is now ready for operation.

14. Perform operating procedures with the M8A1 alarm (M43A1 detector, BA3517/U battery, and M42 alarm) under usual conditions.

- a. Remove rain shield and adapter from handle.
- b. Remove thumbscrew from air inlet. (Remove air outlet cap from air outlet).
- c. Install rain shield and adapter.
- d. Remove 24 VDC input protective cover.
- e. Connect battery cable into 24 VDC input on detector.
- f. Press battery test and reset press button. Detector meter indicates battery voltage and should be in black band. Release.
- g. Observe meter until needle returns to green band.

NOTE: The equipment is now operating.

15. Perform operating procedures with the M8A1 alarm (M43A1 detector, BA3517/U battery, and M42 alarm) under unusual conditions.

a. Operational alert.

- (1) Immediately take protective measures and give alert according to local SOP.
- (2) Disconnect power cable from detector 24 VDC input connector.
- (3) Remove rain shield and adapter assembly from air inlet.
- (4) Store rain shield and adapter assembly in handle.
- (5) Screw thumbscrew on air inlet.
- (6) Screw protective cover on 24 VDC input connector.
- (7) Press air outlet cap on air outlet of detector.
- (8) After a chemical agent attack, decontaminate rain shield and adapter assembly and outside surfaces of all alarm system components.
- (9) Replace M43A1 detector into operation as follows:
 - (a) Remove air outlet cap from air outlet.
 - (b) Remove thumbscrew from air inlet.
 - (c) Remove rain shield and adapter from handle and remove adapter from rain shield. Return rain shield to handle.
 - (d) Remove flowmeter from handle.
 - (e) Press adapter onto flowmeter.
 - (f) Screw flowmeter and adapter into air inlet.
 - (g) Remove protective cover from 24 VDC input connector.
 - (h) Connect power cable connector to 24 VDC input connector. Horn may sound. Adjust horn volume knob.
 - (i) Press battery test and reset press button. Detector meter must be in black band.
 - (j) Ensure ball in flowmeter floats within green band.
 - (k) Remove flowmeter from adapter.
 - (l) Store flowmeter in handle.
 - (m) Remove rain shield from handle and install on adapter.
 - (n) Observe detector meter until needle returns to green band.

NOTE: The equipment is now operating.

b. Operation in cold weather.

NOTE: Use the M253 winterization kit instead of BA3517/U battery during operation below 20°F (-7°C).

- (1) Make sure rain shield and adapter assembly is installed in detector air inlet.
- (2) Make sure air outlet cap is removed from air outlet.
- (3) Remove protective cap from BB501/U battery, and remove protective cap from M168 cable assembly connector.
- (4) Observe shape of BB501/U battery receptacle and M168 cable assembly connector for proper alignment, and connect them.
- (5) Remove protective cover from M168 cable assembly connector and 24 VDC input connector on detector.
- (6) Connect M1-68 cable connector to 24 VDC input connector on detector.
- (7) Press battery test and reset press button and observe detector meter. Meter indicates voltage; needle should be in black band. Release.
- (8) Observe meter until needle returns to green band.

NOTE: It may take as long as 50 minutes for needle to reach green band during cold weather.

NOTE: The equipment is now operating.

- c. Operation in blowing sand or dust. When operating the M43A1 detector in blowing sand or dust, replace the air filter according to Table 1.
 - d. Operation in rain, sleet, or snow. No special procedures are required in rain, sleet, or snow.
 - e. Fording. The M43A1 detector is NOT immersible. Keep above water if river crossing is required.
16. Conduct continuous-use checks and reservicing procedures with M43A1 detector and M42 alarm.
- a. Store rain shield in handle.
 - b. Remove flowmeter from handle.
 - c. Put flowmeter onto adapter.
 - d. Press and hold battery test and reset press button. Read detector meter. Detector meter should read in black band. Release battery test and reset press button.
 - e. Flowmeter ball should read within green band of flowmeter.
 - f. Look at detector meter on top case. Meter should be in green band.
 - g. Press and release bit press button. No flow will show on flowmeter, and alarm horn will sound.
 - h. While alarm is still sounding; turn horn volume knob. Check to see that volume changes from low to high.
 - i. Disconnect power cable from 24 VDC input.
 - j. Remove air filter plug from air filter port.
 - k. Remove air filter and touch to back of hand. It should be warm. Discard if dusty.
 - l. Obtain a test paddle from M273 kit. Insert test paddle and install air filter plug. Connect power. Alarm may sound.
 - m. Press and release battery test and reset press button. Within two minutes alarm should sound.
 - n. Remove air filter plug. Remove test paddle from air filter port. Install serviceable air filter. Reinstall air filter plug. Return test paddle to M273 kit.
 - o. Allow alarm to sound at least five minutes. Then press and release battery test and reset press button.
 - p. Remove flowmeter and store in handle.
 - q. Remove rain shield from handle and place on adapter.
 - r. Conduct horn, light, and battery test on M42 alarm; replace batteries if necessary.
17. Reactivate M8A1 alarm after operational alert. Perform procedure provided at paragraph 5a above.

Evaluation Preparation:

Setup: This task can be evaluated during a field exercise. Gather the necessary equipment and supplies identified in the Conditions statement. Operational alert signals can be simulated by allowing smoke (except cigarette smoke) to come into contact with the M43A1 detector unit. Allow the soldier to use TM 3-6665-312-12&P. Brief Soldier: Tell the soldier to perform all procedures IAW TM 3-6665-312-12&P without causing damage to the equipment.

Performance Measures

	<u>GO</u>	<u>NO GO</u>
1. Performs all operator-level PMCS.	—	—
2. Corrects all deficiencies or shortcomings correctable at operator level; reports all others to supervisor.	—	—
3. Performs assembly and preparation for use procedures.	—	—
4. Performs operating procedures under usual conditions OR Performs operating procedures under unusual conditions.	—	—
5. Conducts continuous-use checks and reservicing procedures.	—	—
6. Reactivates alarm system following an operational alert.	—	—

- 7. Performs all performance measures without causing damage to equipment. _____
- 8. Observes all safety precautions. _____

Evaluation Guidance: Score the soldier GO if all steps are passed (P). Score the soldier NO-GO if any step is failed (F). If any step is failed, show the soldier what was done wrong and how to do it correctly.

References

Required

Related

DA Pam 738-750

APPENDIX A - SWING RHYTHMS

This data is designed to provide the musician with a phonetic system to sing swing rhythms and to provide proper interpretation of long percussive and short percussive notes in the swing idiom.

A-1. Anticipation: Anticipation occurs when a note normally played on the beat is attacked a half beat early. The result is melodic, harmonic, and rhythmic syncopation.

The figure consists of eight musical staves arranged in a 4x2 grid. Each staff begins with a square box containing a 4/4 time signature. The staves illustrate various rhythmic patterns with anticipation:

- Row 1: A whole note followed by a half note.
- Row 2: A quarter note followed by a dotted quarter note with the label "ant" above it; and a quarter note followed by a dotted quarter note with the label "ant" above it.
- Row 3: A quarter note followed by a dotted quarter note; and a quarter note followed by a dotted quarter note.
- Row 4: A quarter note followed by a dotted quarter note with the label "ant" above it; and a quarter note followed by a dotted quarter note with the label "ant" above it, and a quarter note followed by a dotted quarter note with the label "ant" above it.

Figure A-1
Anticipation

A-2. Long Percussive Notes: A long percussive note is defined as any note longer than a quarter note. A quarter note or it's tied equivalent that is marked with a legato marking (-) is considered a long percussive note. On beat long percussive notes, anticipated notes, and quarter notes or their tied equivalents marked long (-) all have the duration of their written value.

Phonetics are:

- Say DOO on long percussive notes.
- Say DOO on quarter notes marked long.

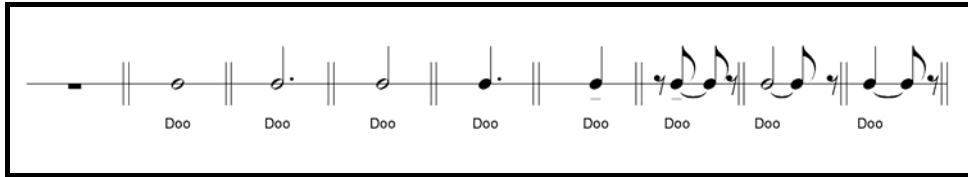

Figure A-2
Long Percussive Notes

A-3. Short Percussive Notes: A short percussive note is defined as any quarter note or its tied equivalent (eighth note tied to an eighth note), or any note shorter than a quarter note. A short percussive note is performed with the duration of the first portion of the subdivided swing quarter note, or 2/3 of a beat. The second portion of the beat (last 1/3 of the beat) is silent as if it were a rest. Articulation markings, (>, ^) do not effect the value of the short percussive note. A short percussive note receives 2/3 of the beat unless marked with a legato marking (-) or a staccato marking (·).

Phonetics are:

- Say DOT on short percussive notes.
- Say DOT on off- beat eighth notes followed by a rest.
- Say DOT on all tied eighth notes unless marked long.

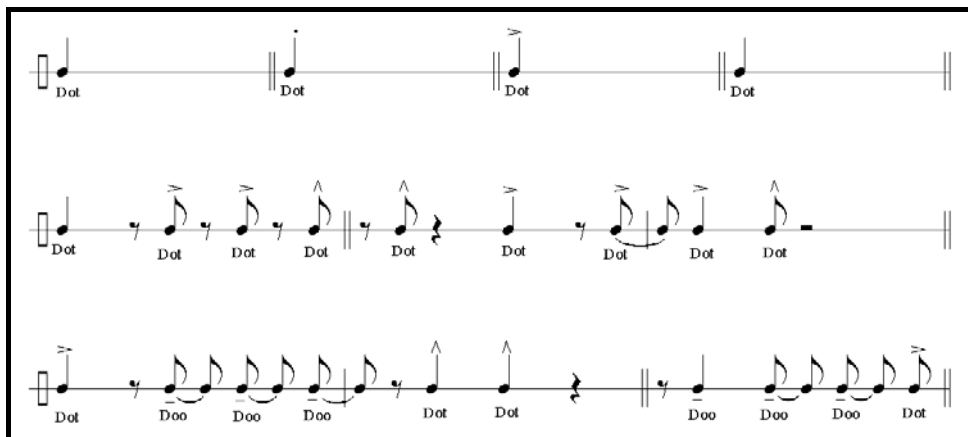

Figure A-3
Short Percussive Notes

A-4. Tongued Notes:

Phonetics are:

- Say DOO when on-beat eighth notes are following a rest or silence.
- Say DOO when on-beat eighth notes are preceding an anticipation.
- Say BAH on off-beat eighth notes following a rest or silence and followed by sound.

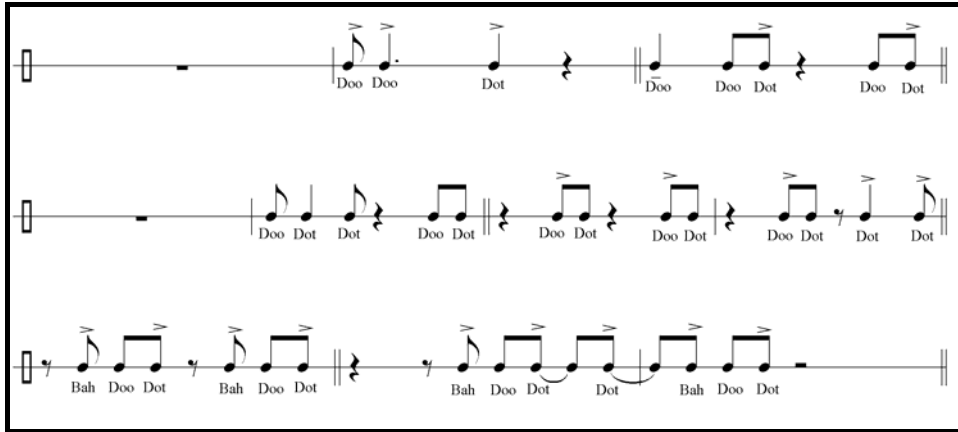

Figure A-4
Tongued Notes

A-5. Neutral Notes:

Phonetics are:

- Say Ooo when on-beat eighth notes are followed by an eighth note.
- Say Vah on off-beat eighth notes when preceded by sound.

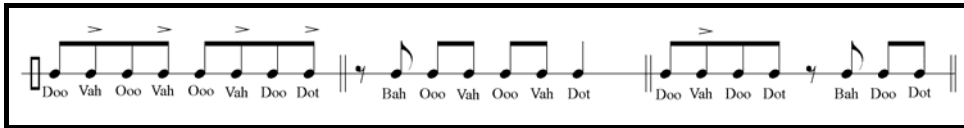

Figure A-5
Neutral Notes

A-6. Triplets:

Phonetics are:

- For eighth notes triplets say Ooo Vah Bah on the three portions of the triplet, respectively.
- For quarter note triplets say DOO on the three portion of the beat.
- The first note of an eighth note triplet will be treated as a tongued note if a rest or silence precedes it.

The image shows two lines of musical notation on a staff, enclosed in a rectangular box. The notation includes various note values (quarter, eighth, and dotted notes) and rests, with triplets indicated by a bracket and the number '3'. Phonetic labels are placed below the notes to indicate how they should be pronounced. The first line contains three eighth-note triplets, followed by a dotted quarter note, a quarter note, another eighth-note triplet, and a dotted half note. The second line contains a quarter-note triplet, two dotted quarter notes, a quarter note, a quarter-note triplet, another quarter-note triplet, a dotted quarter note, and a dotted half note. The phonetic labels are: 'DooVah Bah Ooo Vah Bah Ooo Vah Bah Dot', 'Doo Vah Bah Doo Doo', 'Doo Doo Doo Dot Dot', 'Doo Doo Dot', 'Dot Doo Vah Bah DooDoo Doo', 'Dot Doo Doo', and 'Doo Doo'.

Figure A-6
Triplets

APPENDIX B - IMPROVISATION

Improvisation is a highly creative, spontaneous, and imaginative art form. It can be compared to instant composing. This musical art form lets you compose music instantly using only chord symbols as a guideline. It is used in all types and styles of music, but mainly in swing, jazz, blues, rock, and country. There are many ways to approach improvisation. In this section you will be presented with just one of those ways. Anyone can improvise. You are strongly encouraged to read related books and magazines. Ask players who improvise to describe their method of improvisation. Reviewing chapters 6-11, 13, 15-19 of the *Basic Music* book will help build the foundation that you need for improvisation. Playing scales, in all variations and rhythms, will also help build your playing foundation.

B-1. Diatonic Seventh Chords in Major. The figure below shows all the diatonic seventh chords in C major. Each chord is named according to its quality and function.

Figure B-1a displays the diatonic seventh chords in C Major on a musical staff. The chords are labeled as follows: CMaj7, Dmin7, Emin7, FMaj7, G7, Amin7, and Bmin7(b5). Below each chord symbol is its corresponding Roman numeral: I, ii, iii, IV, V, vi, and vii.

Figure B-1a
Diatonic Seventh Chords in C Major

The ii/V7 progression comes from the strong root progression of a fourth interval leading to the I chord. Using a piano, first play a D, then a G above, and then back down to the one chord or C. Now that you know the root of each chord and its root progression, play it again. The progression in the key of C will look like this: Dmin7 to G7 to C Maj7. You will hear how the ii/V7 pulls towards the I chord. You will eventually learn to recognize this progression easily on sight and with your ears. Since the II chord and V chord are diatonic, you can then simply play in the diatonic key or, like the example that follows, play the C major scale. This example can be transposed to all other major keys.

Figure B-1b illustrates the ii/V7/I progression in C Major. The musical staff shows a scale-like progression of notes, with the chords Dmin7, G7, and CMaj7 indicated above the staff.

Figure B-1b
ii/V7/I in C Major

It's important to remember that the ii/V7 progression is not always written to lead to its I chord. Sometimes it is followed by another ii/V7 progression in another key, often called "the key of the moment." To find the key or scale, simply go down a whole step from the root of the minor seventh chord, or go up a fourth from the root of the dominant chord, whichever is the fastest way of thinking for you. This method can only be used when the chords are being played in root position.

Always use the fastest thought process to think of which scale to use. In a fast tempo song, you don't have much time to think about what you want to do. There is a faster way to play over the ii/V7 chord progression which will fit the chords better and sound better. Simply play the mode that corresponds to that scale degree. The mode on the second scale degree is dorian and on the fifth scale degree is mixolydian. For more information, review chapter 16 (Chord Scales) of the *Basic Music* book.

Look at this example to see how much better the scales fit the chords.

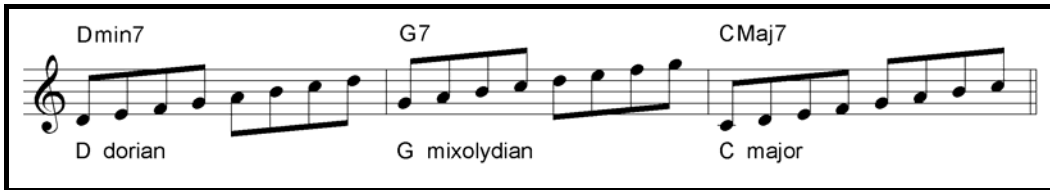

Figure B-1c
Chord Scales in Major

B-2. Diatonic Scales in Minor. The below figure shows the diatonic 7th chords in C minor. Notice that the chords are built on a harmonic minor scale. The harmonic minor scale is needed in order to give us a true dominant chord built on the fifth degree. This dominant chord would be hard to distinguish from the same dominant chord in major so another chord tone is added above the seventh. This becomes the flat 9 of the chord.

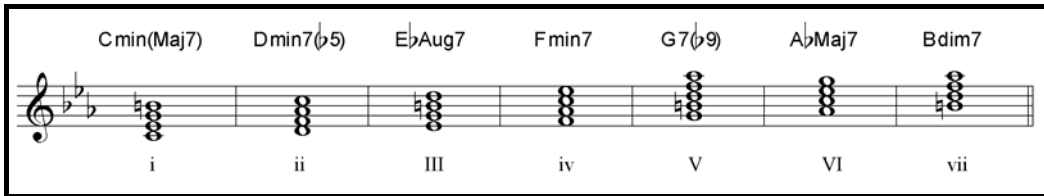

Figure B-2a
Diatonic Seventh Chords in C Harmonic Minor

The ii/V7 progression in C minor will look like this: Dmin7(b5) to G7(b9) to C minor. The min7(b5) chord is also called the half-diminished chord and is quite often seen using the insert symbol (). The quick method for minor ii/V7 progression is similar to the one for major. Simply go down a step from the ii min7(b5) chord or up a fourth from the V7(b 9) chord and play that harmonic minor scale (only if you are playing these chords in root position). See Figure B-2b.

Dmin7(b5) G7(b9) Cmin(Maj7)

Figure B-2b
ii/V/I in Minor

Notice that the harmonic minor scale works well over the I chord if it is a min/Maj7 chord. This chord is seldom used. Usually the I chord will be either a min6 or min7 chord. In other words, not all min7th chords will use the dorian scale. By using your analyzing skills, you will notice that those chords are sometimes acting as minor tonic chords (e.g. "Blue Bossa" and "Summertime") and should use the natural minor scale. The natural minor scale can also be used over the ii min7(b5) chord if the tempo is slow or if the minor ii/V7 progression is spread out over several bars. You would then switch to the harmonic minor on the V7(b9) chord.

Remember, as jazz players we are always looking for the fastest way to think of a scale for a chord. Another way to think of the ii min7(b5) chord is to use the locrian approach borrowed from the major. Play the major scale up a half step from the root of the ii chord. This is the same thing as playing the natural minor scale down a step from the ii chord, because the major scale up a half step is the relative major of the key. This thought process might be a faster way of thinking for some players. You will see this minor progression many times, even in songs that are in major keys.

The minor ii/V7 progression is also seen using a V7(#9). This can be found in volume 3 of the Aebersold collection. The example below that shows the recommended chord scales as seen in this volume.

Dmin7(b5) G7(b9)

D locrian (E^b major) G superlocrian (A^b major with b3)

Figure B-2c
Chord Scales for Minor ii/V

The scale used over the ii chord is D locrian, as mentioned above, and the scale used over the V7(#9) chord is the G super locrian scale. The super locrian is constructed using the melodic minor scale up a half step from the root of the chord. For example, G7(#9) uses the A flat melodic minor scale starting on G. This scale is also called the diminished, whole tone or altered scale (these scales will be discussed later). The fastest thinking process for the player would be to use the melodic minor up a half step from the root of the chord. Remember that ascending melodic minor is simply a major scale with a flat third. These new scales can be practiced with "Blue Bossa" and "Summertime" which are recorded on Volume 54 of the Aebersold jazz play-a-longs.

Modal Scales

B-3. Dorian and Mixolydian Scales. These modes are important scales in jazz improvisation. You will grow immensely by learning these scales. You must practice them just like the major and minor scales. Don't be overwhelmed. You could spend the whole day just practicing scales, but this is not very practical. Spend a couple of days getting the modes under your fingers and then alternate them with your other scales. Some scales might be harder than others, so always put more practice time into those scales that give you the most trouble. Remember, not all songs are in the key of C major.

The following exercises will help you gain knowledge and experience with modes and scales. Play up the dorian scale one octave, then the mixolydian scale up one octave and finish with the major scale creating your own ii/V7/I chord progression. Do this in all keys and with different root movements. Make up your own root movements (be creative) and do a different one everyday.

To gain flexibility, try using a different articulation everyday or play a different articulation every time you switch scales. For a more advanced exercise, play the ii/V7 progression without going to the I chord. Volume 3 of the Aebersold collection is a good one to practice with for ii/V7's. For an applied song to work on, play along with "Satin Doll" in Volume 12 of the Aebersold collection.

B-4. Blues Scale. The blues scale is a very important song form in jazz. The example below gives a simplified version of the F blues scale.



Figure B-4a
Blues Scale

A quick method to play over these changes is to simply use the blues scale of the key you are in. If the first chord is F7, use the F blues scale. The formula for the blues scale is 1, b3, 4, #4 or b5, 5 and b7. You could also use the F minor pentatonic scale, which has the same notes except the b5. For further information, refer to chapter 16 of the *Basic Music* book.

Notice that the blues scale does not really fit well over some of the chords. Look at the very first chord. The F7 chord does not contain an Ab which is a part of the F blues scale. The Ab is considered a blue note, and can be said to give a bluesy sound to the F7 chord. Remember that the blues scale is a quick method and is not meant to be the only scale played. It is always better to mix the blues scale with other scales. The blues scale can be very effective when used occasionally for color during a solo, but can be very boring if used exclusively.

A better way to play over the blues is to use the chord scale that belongs with that chord, (e.g. F7 = F mixolydian). The following example shows a more complex version of the blues and its appropriate scales.

Figure B-4b
Chord Scales Over Blues Progression

Practice the blues using both modal and blues scales. Try playing the blues in all twelve keys using only your metronome. If you would like to practice with a rhythm section, Volume 42 of the Aebersold collection contains blues in all keys.

B-5. Whole Tone and Diminished Scales. The whole tone scale is for use over the augmented 7 or Aug7 chord. The scale is symmetrical and is constructed of whole steps with no half steps. Because of its construction, there are only two whole tone scales. It doesn't take long to memorize this scale. Although there are only two, try practicing them as if there were twelve using different root movements. You want to be able to see an Eb Aug7 and think of the Eb whole tone scale instead of trying to think of which of the two whole tone scales fit Eb. Once again, use the fastest thought process.

You can also use the whole tone scale over dominant chords. This will place a #4 and #5 over the chord. This is an advanced application and the beginner's ear may not accept it. This is called playing "outside the key" or "outside". Using this application mixed with the normal mixolydian approach will help color the solo. This is very helpful in solos which present the dominant chord for several measures. This "outside" method is better for more modern songs and not very appropriate in older swing or big band tunes.

The diminished scale can be constructed two ways:

- 1) Whole step/half step or 21212121.
- 2) Half step/whole step or 12121212.

No matter which method you use, only three diminished scales can be constructed. The diminished 7 or dim7 chord is the preferred method for this scale, using the 21212121 version.

This scale can also be used with altered dominant chords. The half step/whole step fits best with dominant 7(b9) chords because the alterations #9 and #4 are implied. The whole step/half step works with dominant 7(#9) chords because b9, #4, and #5 are implied. The example below gives an illustration of this. This adds yet another scale you can use over the V7(b9) or V7(#9) chord, (e.g. "Blue Bossa").

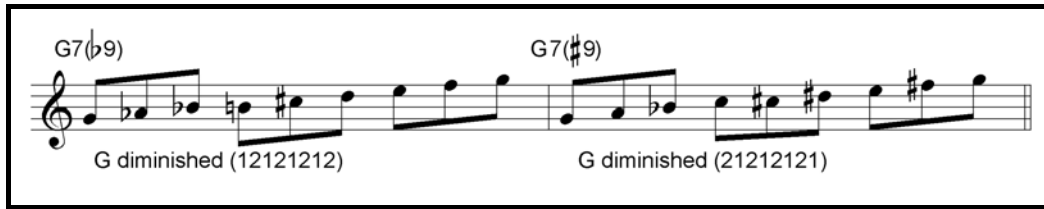

Figure B-5a
Diminished Scales

Some players learn both forms of the diminished scale, while others learn just one form and apply it to the appropriate chords. Although there are only three diminished scales, a good exercise is to practice them as if there were twelve.

As with the whole tone scale, the diminished scale can be used over normal or unaltered dominant chords. Again, you would be playing "outside", but this application can be very colorful and is used by many professionals in the field. Remember to mix this sound along with the appropriate mixolydian scale.

When you analyze songs to perform, you will notice that not all V7 chords are acting in a dominant relationship, and not all major 7 chords are acting in a tonic relationship. In this case, you should play the lydian versions of these chord scales.

As an example, look at the chord progression example. The G7 is definitely not the V7 of E flat minor. The better choice for scale use would be the G lydian seventh scale or G mixolydian with a raised fourth. The DMaj7 chord doesn't look like it really belongs (there are no ii/V7 progressions or any dominant chords pulling towards it). The better scale would be D lydian or D major with a raised fourth. For further information, refer to chapter 16 of the *Basic Music* book.



Figure B-5b
Chord Progression Example

Never quit

Remember that a jazz soloist is creative and skilled. Jazz improvisation is an ongoing process of constant learning, researching, and growing.

GLOSSARY**Section I**
Abbreviations

AA	antiaircraft
ABC	atomic biological chemical
AC	Active Component
ack	acknowledge
AF	augmentation force
AG	Adjutant General
AL	Alabama
amp	amputated
an	annually
AP	Antipersonnel
APC	armored personnel carrier
app	appendix
AR	= Army Regulation; = Army Reserve
AS	Australia; area security
AT	Anti-Tank
ATGM	antitank guided missile
AV	Audiovisual
BC	Branch Code
BL	low battery
BR	battle roster
BT	Basic Training
C	centigrade
CA	civil affairs
CAL	Center of Army Leadership
CG	Commanding General

CGA	Color Graphics Adapter
cGy	Centigray
chap	chapter
CI	civilian internee
civ	civilian
CLP	cleaner lubricant preservative
cm	centimeter
CO	Commissioned Officer
COL	colonel
Con	control
cont	continued
CP	command post
CS	combat support; or O-chlorobenzyl-malononitrile;
CTA	Common Table of Allowances
DA	Department of the Army
DA Form	Department of the Army Form
DA Pam	Department of the Army Pamphlet
DC	Dental Corps
DE	directed energy
decon	decontamination
DO	Delivery Order
DoD	Department of Defense
DP	Dual Purpose
DS	direct support
DS2	decontaminating solution #2
E	east
e.g.	for example
Ea	Each

EAT	external air transport
Employment	To commit a force in support of an operation plan.
EN	Corps of Engineers
EPW	enemy prisoner of war
EPW/CI	enemy prisoners of war and civilian internees
ER	evaluation report
etc	et cetera
etc.	et cetera
F	fahrenheit
FA	Functional Area
FI	Finance Corps
fig	figure
FM	Field Manual
FO	Forward Observer
frag	fragmentation
FY	Fiscal Year
G	nerve agent
GS	General support
Gy	Grays
H	blister agent
HE	High Explosive
HEAT	High Explosive Anti-Tank
hr	hour
i.e.	that is
IAW	in accordance with
ID	identification
IL	Illinois
IN	Infantry

Indirect fire	Fire delivered at a target which cannot be seen by the aimer.
Inf	Infantry
Instr	Instruction
IR	infrared
ITV	in-transit visibility
JP	Joint Publication
km	kilometer
L	left
lab	laboratory
LAW	light antitank weapon
lb	pound
lc	light case
LIN	line item number
LO	Learning Objective
LP	Listening Post
M	meter
MA	marshalling area
MC	Medical Corps
MCT	movement control team
MD	Military Deception
MG	machine gun
MI	Military Intelligence
min	minute
mo	monthly
MOPP	Mission Oriented Protective Posture
MOS	Military Occupational Specialty
MP	Military Police
MTOE	Modified Table of Organization and Equipment

N	north
NA	not applicable
NATO	North Atlantic Treaty Organization
NBC	nuclear, biological, or chemical
NCO	Non-commissioned Officer
NCOIC	Non-commissioned Officer In Charge
NG	National Guard
No	number
OF	Observed Fire
OIC	officer in charge
OP	Observation Post
OPS	operations
OPSEC	operations security
OT	Observer Target
P	pass
Pam	Pamphlet
para	paragraph
PB	particle beam, property book
PD	Points of Departure
PI	protected identity
PK	professional knowledge
PM	Program Manager
PMCS	preventive maintenance checks and services
PP	Passage Point
Pract	Practice
prep	prepare
Procedure	A standard and detailed course of action that describes how to perform a task.
PS	personnel services

PT	physical training
PW	prisoner of war
R	right
RA	Regular Army
rad	roentgens
Reg	Regiment
RP	release point
S	safe
S2	Battalion Intelligence Officer
SA	Saudi Arabia
SAC	special agent in charge
SC	Signal Corps
sec	second
SF	Standard Form
SI	Skill Identifier
SM	Soldier's Manual
SMCT	Soldier's Manual of Common Tasks
SOI	Signal Operation Instruction
SOP	Standard Operating Procedure
SP	start point
SSI	Special Skill Identifier
STP	Soldier Training Publication
TA	target analysis
Tab	Table
Task standard	See "Standard."
TB	Technical Bulletin
TC	Training Circular; or Technical Coordinator
TD	Training Development

TDA	Table of Distribution and Allowances
TG	Trainer's Guide
TIO	training information outline
TM	Technical Manual
TOE	Table of Organization and Equipment
TOW	tube-launched, optically tracked, wire-guided
TP	Target Practice
TR	TRADOC Regulation
U	up
unk	unknown
US	United States
USC	United States Code
V	nerve agent
VA	Virginia
VC	Veterinary Corps
VI	Visual Information
VIS	Visual
Vol	Volume
W	wire mode
Z	zulu time (Greenwich Mean Time)

Section II

Terms

Soldier's Manual of Common Tasks (SM): Lists critical task summaries for a specific MOS and skill level (SL); provides conditions, standards, and performance measures for each critical task; and is the base document for all MOS-specific individual task training and evaluation.

REFERENCES

Professional References

Texts

- Bertoni, Umberto. *12 Studies for Bassoon*. New York: International Music Co, 1971.
- Bianchi, Virginio. *12 Etudes for Bassoon*. New York: G. Schirmer, Inc, 1971.
- Bitsch. *20 Etudes for Bassoon*. M. Baron Co.
- Bozza. *15 Daily Studies for Bassoon*. M. Baron Co.
- Davies. *Scales and Arpeggios for the Bassoon*. Boosey and Hawkes.
- Dubois, Pierre. *12 Studies for Bassoon*. Paris: A. Leduc, 1957.
- Gambara, J.B. *18 Studies*. New York: International Music Co, 1951.
- Jancourt, Eugene. *26 Melodic Studies*. New York: International Music Co, 1956.
- McDowell. *Practical Studies, (Books I and II)*. Belwin Mills Publishing Co.
- Milde, Ludwig. *Concert Studies for Bassoon, Op. 26*. New York: International Music Co, 1948.
- Orefici, Alberto. *20 Melodic Studies for Bassoon (Studies and Exercises)*. New York: International Music Co, 1966.
- Oubradous, F. *Technical Exercises Part for Independence of Fingers*.
- Piard, Marius. *16 Characteristic Studies for Bassoon*. New York: International Music Co, 1950.
- Piard. *24 Studies for the Bassoon*. International Music Co.
- Piard. *90 Studies, (Three Volumes)*. M. Baron Co.
- Pivonka. *Rhythmic Studies for Bassoon*. Frank Music Corp.
- Popkin, Mark/Glickman, Loren. *Bassoon Reed Making*. Evanston, IL: The Instrumentalist Co, 1969.
- Spencer/Mueller. *The Art of Bassoon Playing*. Summy-Brichard.
- Waterhouset. *30 Classical Studies*.
- Weait. *Bassoon Warm-ups*.
- Weissenborn, Julius. *Practice Method for Bassoon*. New York: Carl Fischer, Inc, 1941.

Websites

Double Reeds WebRing----<http://www.webring.org/cgi-bin/webring?ring=doublereed;list>
Bassoon WebRing-----<http://www.webring.org/cgi-bin/webring?ring=bassoon;list>
Gail Warnaar Double Reeds----www.DoubleReedShop.com
Double reed supply site-----<http://www.georgrieger.com/html-en/home/index.html>
Reed adjustment information site-----<http://www.canit.se/~chrisdav/reedadj.html>

This listing is not intended to be all-inclusive, and some of the sites have extensive links pages. No endorsement by any government agency is implied in the inclusion of any link on this page.

Video

Video Clinic Series: "*Bassoon Basics*", produced by *The United States Field Band*.
The address for ordering this valuable addition to your training library is:
The U.S. Army Field Band, Bldg. 4700, Fort Meade, Maryland 20755-5330
Phone # (301) 677-6231 Fax # (301) 677-6533 E-mail: <http://www.fldbnd@emh1.ftmeade.army.mil>
More Information: <http://www.army.mil/fieldband/edu.htm>

Comment [DK39]: should this go in the references section?

Required Publications

Required publications are sources that users must read in order to understand or to comply with this publication.

Army Regulations

- AR 25-50. *Managing Correspondence*. 5 March 2001.
- AR 380-5. *Department of The Army Information Security Program*. 29 September 2000.
- AR 700-84. *Issue and Sale of Personal Clothing*. 28 February 1994.
- AR 710-2. *Supply Policy Below the Wholesale Level*. 31 October 1997.

Department of Army Pamphlets

- DA Pam 710-2-1. *Using Unit Supply System: Manual Procedures*. 31 December 1997.

Other Product Types

- DA Form 2404. *Equipment Inspection and Maintenance Worksheet*. April 1997.

Technical Manuals

- TM 11-5805-201-12. *Operator's and Organizational, Maintenance Manual for Telephone Set, TA-312/PT*.
- TM 11-5805-243-13. *Operator's Unit, and Intermediate Direct support Maintenance Manual For Telephone Set TA-312/PT*.
- TM 3-4230-204-12&P. *Operator's and Unit Maintenance Manual (Including Repair Parts and Special Tools List) for Decontaminating Apparatus. Portable, DS2, 1 1/2 Quart, ABC M11*.

Training Circulars

- TC 12-41. *Basic Music*. April 1986.
- TC 12-42. *Harmony*. November 1984.
- TC 24-20. *Tactical Wire and Cable Techniques*. 3 October 1988.

Related Publications

Related publications are sources of additional information. They are not required in order to understand this publication.

Army Regulations

- AR 105-31. *Record Communications*.

Field Manuals

- FM 1-08 (FM 12-50). *U.S. Army Bands*. 15 October 1999.

Other Product Types

- DA Pam 738-750. *The Army Maintenance Management System (TAMMS)*. 1 August 1994.

Technical Manuals

- TM 11-5805-201-12. *Operator's and Organizational, Maintenance Manual for Telephone Set, TA-312/PT*.

Training Circulars

- TC 12-41. *Basic Music*. April 1986.
- TC 12-42. *Harmony*. November 1984.

STP 12-02K-12-SM-TG
30 JULY 2001

By Order of the Secretary of the Army:

Official:



JOEL B. HUDSON

*Administrative Assistant to the
Secretary of the Army*

0122621

ERIC K. SHINSEKI
*General, United States Army
Chief of Staff*

DISTRIBUTION:

Active Army, Army National Guard, and U. S. Army Reserve: Not to be distributed. Electronic Means Only.

PIN: 065890-000